

POWERCORE

Rel. 03 - 01/26



Management System
ISO 9001:2015



www.tuv.com
ID 9105038848

TABLE OF CONTENTS

EN 16005



1. INTRODUCTION	4
1.1. INSTRUCTIONS FOR THE INSTALLER (SAFETY OBLIGATIONS) AND RESIDUAL RISKS	4
1.2. WARNINGS FOR THE USER.....	5
1.3. DISASSEMBLY, RECYCLING AND DISPOSAL	6
1.4. SYMBOL MEANING	7
2. POWERCORE – INTENDED USE / INSTALLATION CONFIGURATION.....	8
2.1. LIMITS OF USE.....	8
2.2. PROHIBITED USE	8
2.3. INSTALLATION CONFIGURATION	9
3. POWERCORE CONTROL MODULE.....	10
3.1. CAUTION	10
3.2. POWERCORE CONTROL MODULE DESCRIPTION.....	11
3.2.1. POWER SUPPLY	12
3.2.2. ELECTRONIC BOARD.....	14
4. POWERCORE CONTROL MODULE CONNECTIONS.....	16
4.1. QUICK-CONNECTION PERIPHERALS	16
4.1.1. MOTOR AND ENCODER CONNECTION	17
4.1.2. ELECTRIC LOCK CONNECTION	18
4.1.3. CONNECTING LEAD-ACID BATTERIES	19
4.1.4. CONNECTING NIMH BATTERIES	20
4.2. LEELECTRONIC BOARD CONNECTORS.....	21
4.3. SENSOR AND PERIPHERAL CONNECTION DIAGRAMS.....	24
4.3.1. SENSORS	24
4.3.2. DIGIDOR connection diagram	29
4.3.3. ICON Connection Diagram	30
4.3.4. Roto K3/Roto K5 connection diagram.....	31
4.3.5. External Key Contact connection diagram (OPTIONAL):.....	32
4.3.6. AUX-OUT connections.....	33
4.3.7. AUX-IN connections	34
5. USER INTERFACE	35
5.1. Display and Function Keys.....	35
5.2. Digidor	37
5.3. Parameters.....	40
5.4. Operating Controls.....	44
5.4.1. Sd Procedure (SET TO DEFAULT)	45
5.4.2. System Information In.....	46
5.4.3. Display Display Selection dS.....	48
6. COMMISSIONING	53
6.1. GETTING STARTED.....	53
6.2. Commissioning Sequence	54

6.2.1. Power supply connection.....	54
6.2.2. Power On Display	55
6.2.3. Quick LP Procedure via User Interface.....	56
6.2.4. LP Procedure via User Interface.....	57
6.2.5. Set Up procedure using the Digidor selector	58
6.2.6. Parameter Adjustment.....	62
6.2.7. Final Verification	62
7. DIAGNOSTIC	63
7.1. Irregular Operation, Causes / Solutions	63
7.2. Errors on the inputs of the SAFE Close 1 and 2, SAFE Open 1 and 2 safety devices:	64
7.3. Abnormal states at the time of ignition	65

1. INTRODUCTION

Thank you for your preference for this product. In order to obtain the best performance from the operator, Sesamo recommends that you carefully read and follow the installation and use instructions in this manual. The installation of this operator must be carried out only by professionally competent persons to whom this manual is addressed. Packaging materials (wood, plastic, cardboard, etc.) must not be dispersed in the environment or left within the reach of children as a potential source of danger. Before starting the installation, make sure that the product is intact and has not suffered damage resulting from transport or poor storage.

Before carrying out any operation, it is necessary to read this manual carefully and follow all its instructions, with particular attention to those marked by the following references:

	DANGER	Indications that, if not scrupulously followed, could generate sources of danger or death
	CAUTION	indications that, if not followed scrupulously, could generate malfunctions



1.1. INSTRUCTIONS FOR THE INSTALLER (SAFETY OBLIGATIONS) AND RESIDUAL RISKS

1A) The operator is supplied with a single package, which can be handled by hand. For handling, refer to the weight indicated on the packaging, considering that for each person the maximum weight that can be handled must not exceed 20 kg.

1B) The doors are supplied packaged on pallets whose weight is indicated on the packaging. The handling of the entire pallet must be carried out with a pallet truck, or by opening the packaging and carrying out the manual handling of the individual pieces as described in point 1 above. In this operation, the use of suitable personal protective equipment is required, at least safety shoes and gloves.

1) It is important for the safety of persons to install the operator in accordance with the instructions. Incorrect installation or incorrect use of the product can cause serious injury to persons. Installation must be done only by qualified and skilled personnel and in full compliance with current regulations.

2) Read the instructions carefully before starting the installation of the product.

3) Keep the instructions for future reference.

4) This product has been designed and constructed solely for the use indicated in this documentation. Any other use not expressly indicated could compromise the integrity of the product and/or represent a source of danger. Every single phase of the installation must be carried out in accordance with the regulations in force and in any case according to the dictates of Good Technique.

5) SESAMO declines any responsibility derived from improper use or use other than that for which the operator is intended and indicated in this documentation.

6) Do not install the appliance in an explosive atmosphere: the presence of flammable gases or fumes constitutes a serious safety hazard.

7) SESAMO is not responsible for non-compliance with Good Technique in the construction of the closures to be motorized, as well as for deformations that may occur during use.

8) Before installing the product, make sure that each architectural and structural element of the entrance (automatic fixing surface, fixtures, etc.) is suitable and robust enough to be automated.

9) Before carrying out any work on the system, disconnect the power supply. Check that there is a residual current circuit breaker with a threshold not exceeding 0.03 A and adequate overcurrent protection upstream of the system. Check that the earthing system is made in a workmanlike manner. Also ensure that it is not possible to restore the electrical supply inadvertently or unintentionally (e.g. padlock switch or plug/socket combination in sight of the technician who is operating the machine).

10) Also disconnect any backup batteries if present.

11) Before connecting the power supply, make sure that the data on the rating plate corresponds to those of the electrical distribution network.

12) Before installing the product, carry out a careful risk analysis and make all structural changes relating to the construction of safety clearances and the protection or segregation of all crushing, shearing, conveying and danger areas in general, in accordance with the provisions of the EN 16005 standard or any local installation regulations. Verify that the existing structure has the necessary requirements for strength and stability

- 13) Fit safety devices of the type in accordance with EN 12978 that allow any danger areas to be protected from mechanical risks of movement in relation to the risk analysis carried out, such as crushing, conveying, and shearing. Sesamo declines all responsibility for the safety and proper functioning of the operator if components from other manufacturers are used.
- 14) For maintenance, use only original SESAMO parts. Ask SESAMO for spare parts by indicating the serial number shown on the identification plate.
- 15) Do not make any changes to the components that are part of the operator system.
- 16) The installer must provide all information regarding the manual operation of the system in the event of an emergency.
- 17) The doors to be automated must have a uniform and friction-free opening and closing movement
- 18) Anything not expressly provided for in these instructions is not permitted.
- 19) This manual is intended for professional installers or competent people only.
- 20) At the end of the installation, give the user this manual, and in particular the WARNINGS FOR THE USER section and any further information for the correct use of the system.
- 21) Upon completion of the installation, apply a door identification plate
- 22) At the end of the installation, assess the possible presence of hazards whose elimination/mitigation is not possible, for example risk of slipping, tripping, falling due to slippery surfaces due to rain, snow, ice and report their presence to the user as residual risks.

1.2. WARNINGS FOR THE USER

 **WARNING** Read and follow the Warnings and Instructions accompanying the product carefully, as improper use may result in damage to persons, animals or property. Keep the instructions for future reference and pass them on to any successors in the use of the system.

This product is intended only for the use for which it was expressly designed. Any other use is to be considered improper and therefore potentially dangerous. The manufacturer cannot be held responsible for any damage caused by improper, erroneous and unreasonable use.

 **GENERAL SAFETY**

Thank you for your preference for this product. In order to obtain the best performance from the operator, Sesamo recommends that you carefully read and follow the instructions for use in this manual

This product complies with recognized technical standards and safety regulations when properly installed by qualified personnel and professional installers.

The operator, if installed and used correctly, meets the safety standards in use. However, it is advisable to observe some rules of conduct to avoid accidental inconveniences:

- Keep children out of the range of the operator, particularly during movement.
- Do not allow children to play or stand within range of the operator. Children must not play with the appliance.
- Do not run through the door while the door is closing
- Cleaning and maintenance intended to be carried out by the user must not be carried out by children without supervision.
- Avoid working near hinges or moving mechanical parts.
- Do not oppose the movement of the leaf and do not attempt to open the door manually if the actuator has not been unlocked with the appropriate release.
- The breakage or wear of mechanical parts of the door (guided part), such as cables, springs, supports, hinges, guides... could generate dangers. Have the system checked periodically by qualified personnel and SAFErto (professional installer) as indicated by the installer or door manufacturer.
- Keep the sensor optics clean. Check that objects such as curtains, branches or other objects do not disturb the safety devices.
- Do not use the operator if it needs repair. In the event of a breakdown or malfunction of the operator, disconnect the mains power supply to the operator, refrain from any attempt at repair or direct intervention, and refer only to qualified personnel and professional installer for the necessary repair or maintenance. To allow exit, turn on the emergency release (if equipped).
- Have the integrity and correct operation of the operator checked by qualified personnel and professional installer, in particular all safety devices, with the frequency set out in the user manual.
- Installation, maintenance and repair work must be documented, and the relevant documentation must be kept available to the user.
- Failure to comply with the above may create dangerous situations.

1.3. DISASSEMBLY, RECYCLING AND DISPOSAL

WARNING! This product falls within the scope of Directive 2012/19/EU concerning the management of waste electrical and electronic equipment (WEEE). The appliance should not be disposed of with household waste as it is made from a variety of materials that can be recycled at the appropriate facilities. Inquire through the municipal authority regarding the location of the ecological platforms suitable for receiving the product for disposal and its subsequent correct recycling. It should also be noted that in the event of the purchase of an equivalent appliance, the distributor is required to collect the product to be disposed of free of charge. The product is not potentially dangerous for human health and the environment, as it does not contain harmful substances as per Directive 2011/65/EU (RoHS), but if abandoned in the environment it has a negative impact on the ecosystem.



Dismantling operations must be managed by qualified and SAFE personnel and in full compliance with current regulations. These operations must include:





- Disconnect the mains power supply and batteries if present.
- Disconnect all electrical cables connecting to external devices
- disassembly of sliding and fixed sashes using due care to prevent the fall of the sashes themselves or components such as sliding trolleys.
- Dismantling the operator















The symbol of the crossed-out wheeled bin indicates that this product complies with the regulations relating to waste electrical and electronic equipment. Leaving the equipment in the environment or illegally disposing of it is punishable by law.

1.4. SYMBOL MEANING

	DANGER	It indicates that, if not scrupulously followed, could generate sources of danger or death
	CAUTION	It indicates that, if not followed scrupulously, could generate malfunctions
	WARNING RISK OF ELECTROCUTION	It indicates a risk of electrocution. The operation must be carried out in compliance with safety regulations

	Protective helmet required.
	Safety shoes are mandatory.
	Mandatory mask/goggles suitable for eye protection.
	Work gloves are mandatory.
	Ear defenders are mandatory.
	Mandatory overalls.

	Hex Wrench + Size		Circular saw
	Allen key + size		Metal drill bit
	Socket wrench		Masonry drill bit
	Flat screwdriver		Thread Tap M...
	Phillips screwdriver		Bubble / Level
	Torque Adjustable Tool		Wire stripping pliers

2. POWERCORE – INTENDED USE / INSTALLATION CONFIGURATION

The POWERCORE operator must only be used for the movement of sliding pedestrian doors. The POWERCORE control panel is equipped with a special input to work in combination with sensors compliant with EN 13849-1:2015 performance level "c"

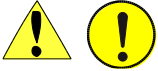

Any other use, other than that stated in the chapter, is NOT PERMITTED by the installer. Sesamo declines any responsibility derived from improper use or use different from that for which the operator is intended.

2.1. LIMITS OF USE

The POWERCORE operator should not be used under the following conditions:

- Direct exposure to the elements
- Direct exposure to water jets of any size or flow rate
- Outside the prescribed technical limits
- Connections to energy sources other than those prescribed – FORBIDDEN

2.2. PROHIBITED USE

It is forbidden:

- Use operator DIFFERENTLY FROM ITS INTENDED USE.
- Use operator to make entrances for fire and smoke protection.
- Use the operator in places where there is a risk of fire/explosion (presence of gases, flammables, etc. the product is not certified with the ATEX directive).
- Integrate unforeseen commercial parts
- Integrate commercial parts for uses not permitted by their respective manufacturers.
- Use commercial devices for use other than as intended by their manufacturers.

2.3. INSTALLATION CONFIGURATION

The operator is designed to work with different configurations of accessories and peripherals. The image shows an example of a complete installation where the possible access points in the box of the operator for the connection of the following peripherals are highlighted.

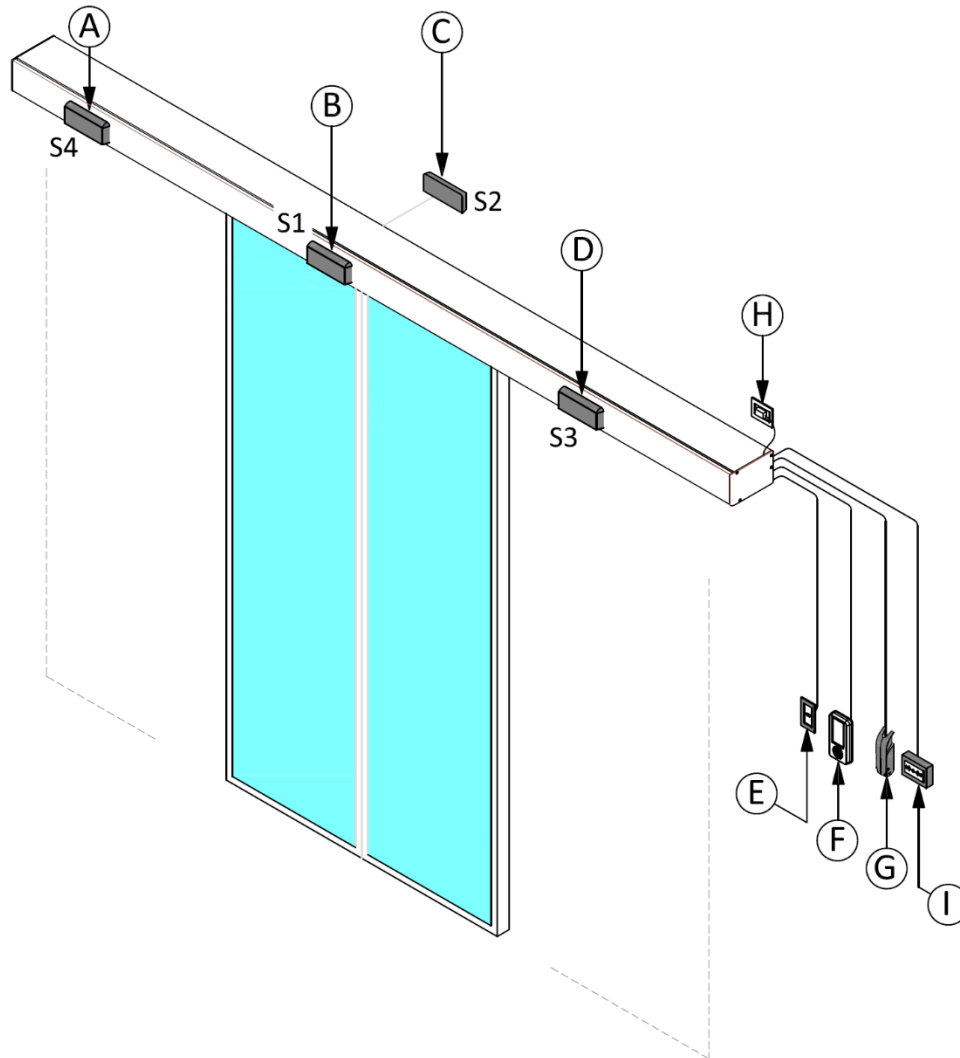

FIGURE 1

A	Safety sensor on the left side opening.	F	Icon/Digidor/RotoK3/RotoK5 operating logic selectors
B	Internal safety sensor when closing and opening control.	G	Lever for manual electro-lock release (Optional, with electro-lock).
C	External safety sensor when closing and opening control.	H	230Vac power supply.
D	Safety sensor on the right side	I	Open button (Optional).
E	Residual current circuit breaker (230Vac mains power supply). NOT PROVIDED		

Prepare the access points inside the operator to allow them to be connected with external peripherals. To pass the mains power cable, use the notch provided on the head or make one affixed to the aluminium case profile. Protect the cable with the cable rubber supplied.

WARNING: Do not damage the cable during the fastening tasks described.



3. POWERCORE CONTROL MODULE

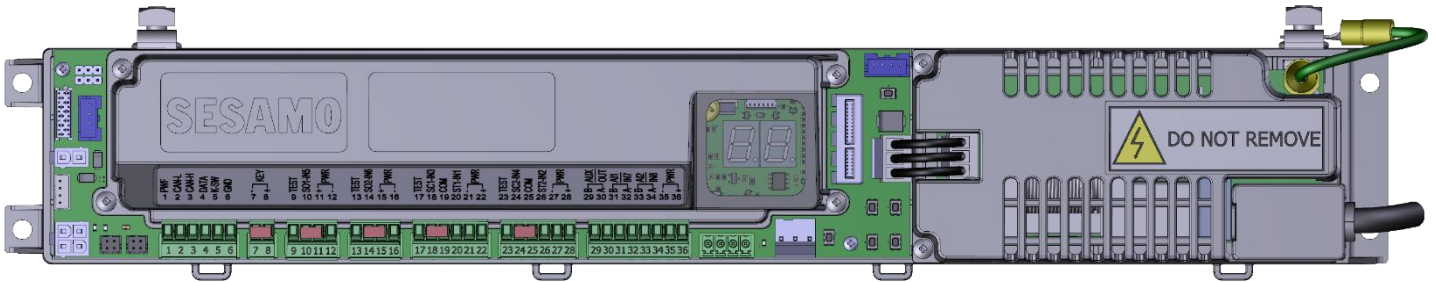

3.1. CAUTION

The POWERCORE control module is designed to manage Sesamo production operators, complies with the specifications of the EN16005 standard and is designed to work with peripherals compliant with the same standard in order to allow the creation of complete automatic inputs according to the highest safety standards.

The POWERCORE control module must only be used for Sesamo production operator and must be configured and put into operation by professionally qualified personnel, following all the instructions in this manual with particular attention to recalls: **danger, warning, note**.

The POWERCORE control module is designed to configure its operating parameters in self-learning mode to ensure quick and easy installations.



Do not wash, disassemble, modify, repair, remove the protective covers of the electronic components of the POWERCORE control module under any circumstances, failure to do so may result in fatal electric shock or irreversible damage to the product.



Do not carry out any operation on the POWERCORE control module, except for adjustments using the appropriate buttons, without first disconnecting the mains power plug, otherwise fatal electric shock or irreversible damage to the product may result.



The POWERCORE control module is designed to work inside products manufactured by Sesamo according to precise manufacturer's specifications. Any other use not explicitly provided for by the manufacturer exposes people and/or property to mortal risks and/or damage of various kinds not foreseeable by the manufacturer itself and therefore must be avoided at all costs.



The POWERCORE control module is designed to operate in a dry environment, protected from any atmospheric agent and any infiltration of water or other liquids. Failure to do so may result in fatal electric shock or irreversible damage to the product.



Inside the POWERCORE control module are parts with voltage levels above 600V that pose a fatal electrical hazard to human life. To avoid this risk, the protective casings must not be removed and dismantled under any circumstances and liquids of any kind must not be spilled that could cause fatal electric shock or irreversibly damage the product.

3.2. POWERCORE CONTROL MODULE DESCRIPTION

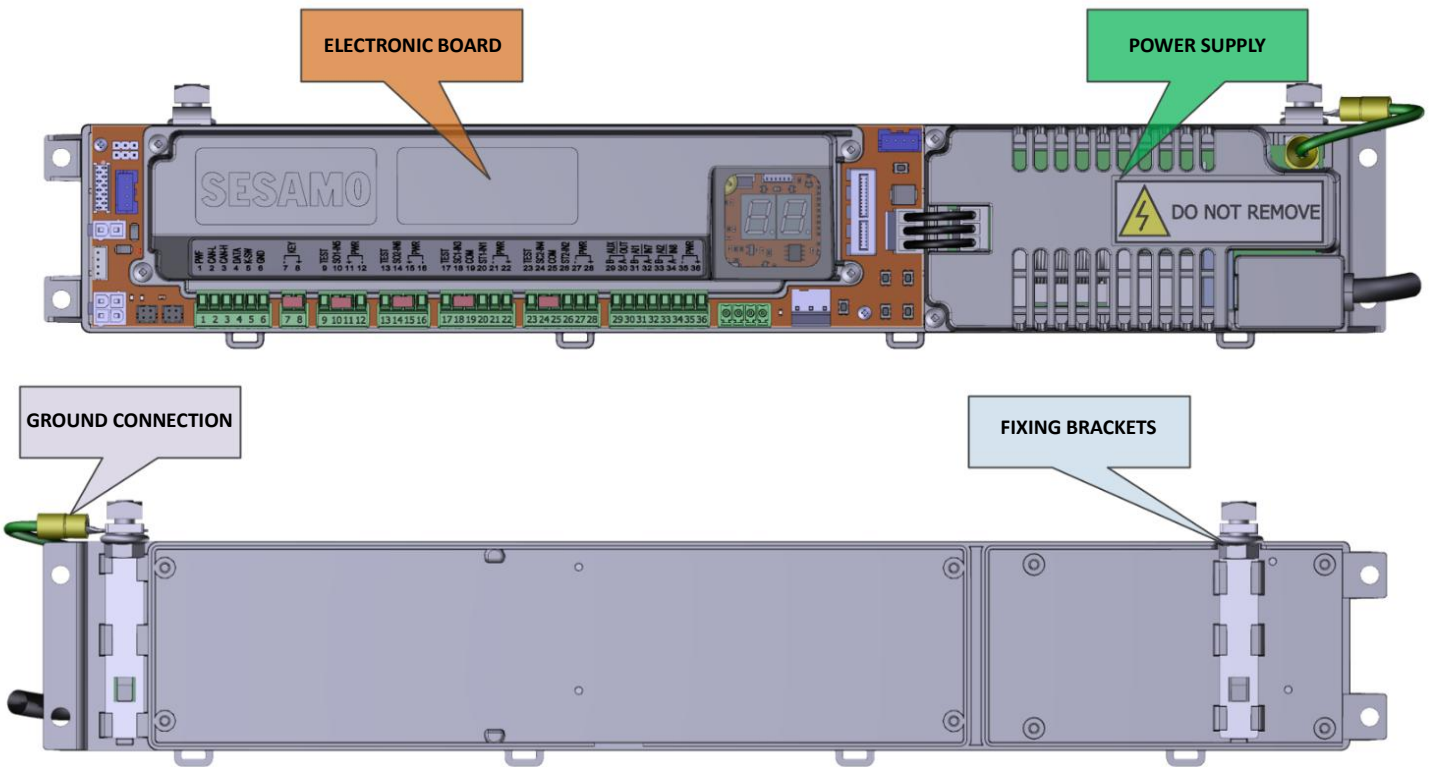



Control module supplied with all jumpers for initial commissioning

DESCRIPTION	NOTES
Cable with eyelet for connection to earth.	<p>The control panel through the earth connection of the electricity grid offers additional protection for the aluminum box and the metal parts connected to it.</p> <p style="text-align: center;"></p> <p>Check for the presence of the cable with eyelet. Failure to do so may impair an important safety function of the entire system and result in fatal electric shock or product malfunction</p>

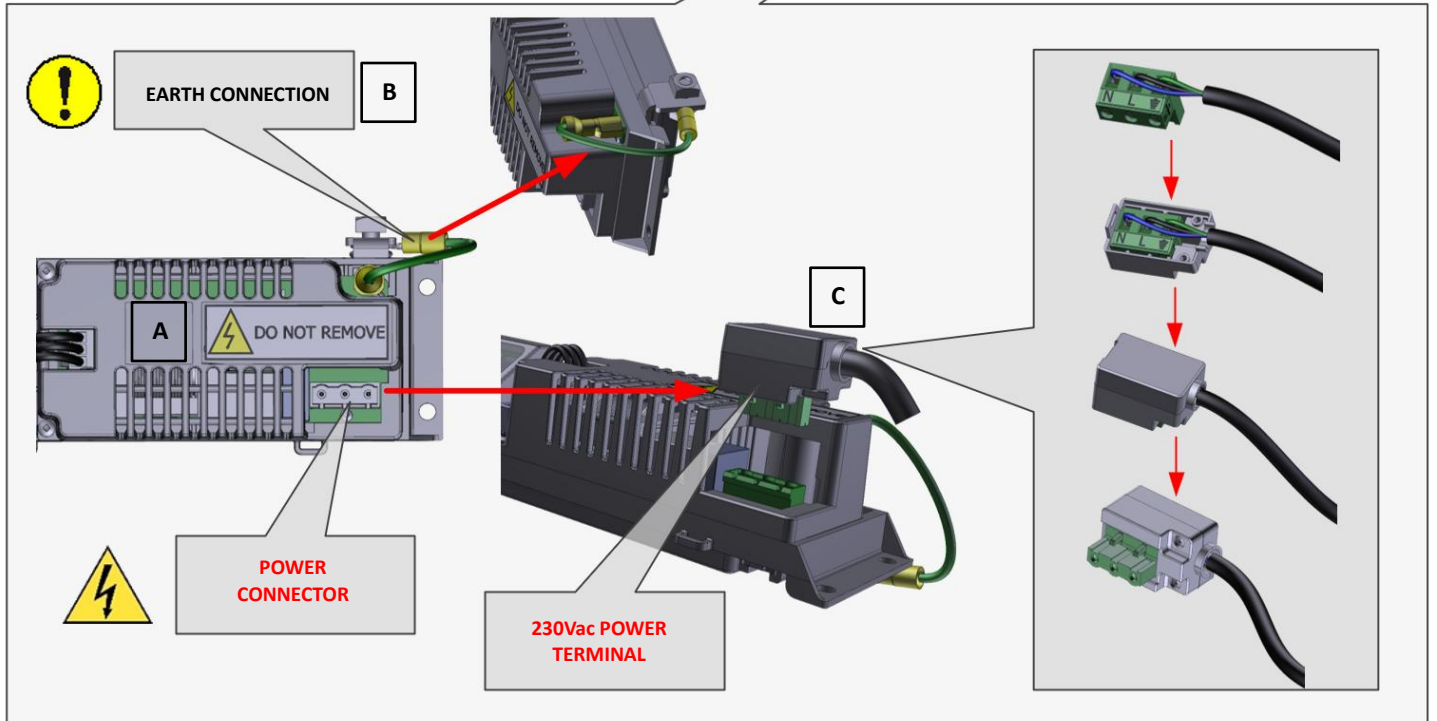
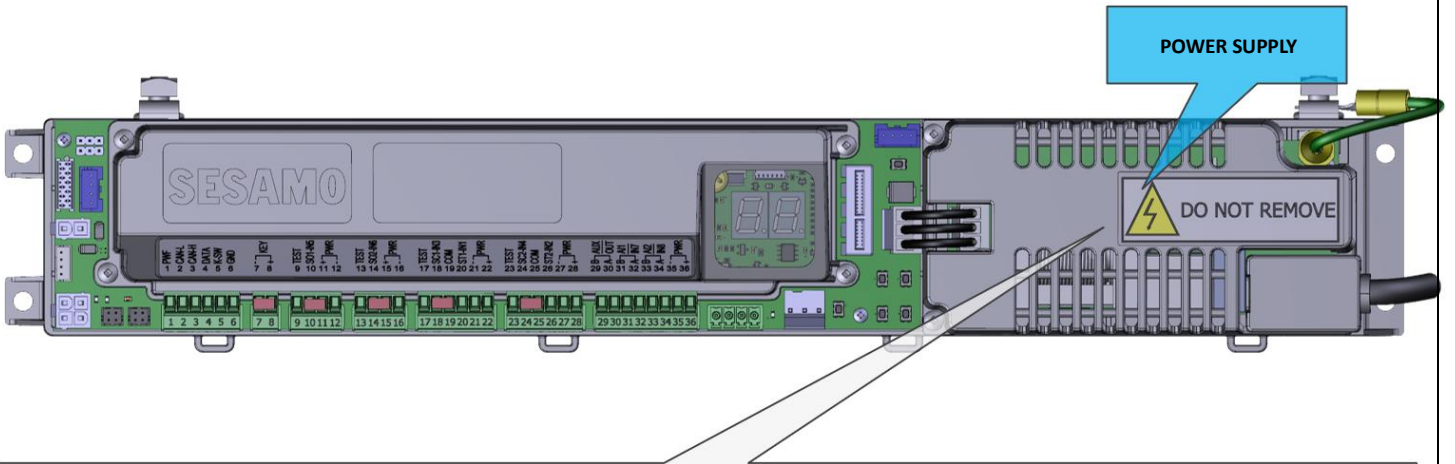
3.2.1. POWER SUPPLY

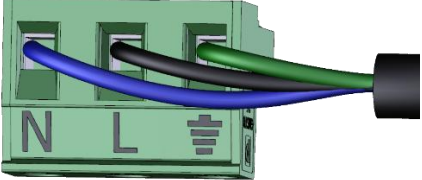

POWERCORE Power Supply Module

INDEX	DESCRIPTION	NOTES
A	Switching power supply, transforms the mains power supply (230Vac) into an output voltage of 40Vdc for the control panel.	<p style="text-align: center;"></p> <p>The switching power supply has inside points with voltages of about 600V which constitute a mortal risk. Do not remove the base and the protective cover for any reason, do not spill liquids on these parts, do not insert any type of object, especially metal, between the ventilation slots of the cover. Failure to do so may result in fatal electric shock or irreversible damage to the product.</p>
B	Connecting the earth protection	<p>The POWERCORE control panel offers additional protection for the aluminium box and the metal parts connected to it through the ground connection of the power grid.</p> <p style="text-align: center;"></p> <p>Make sure the connection is made. Failure to do so may impair an important safety function of the entire system and result in fatal electric shock or product malfunction</p>
C	230Vac Power Supply Terminal	<p>The Power Supply Terminal consists of a 3-pole cable on which the 230Vac main power supply cable must be wired as shown in the figure, the terminal must then be inserted into its protective shell closed by two screws.</p> <p style="text-align: center;"></p> <p>Pay particular attention to the indications on the terminal of the Phase, Neutral and Ground connections. Incorrect connection may damage the product:</p> <p style="text-align: center;"></p>

3.2.2. ELECTRONIC BOARD

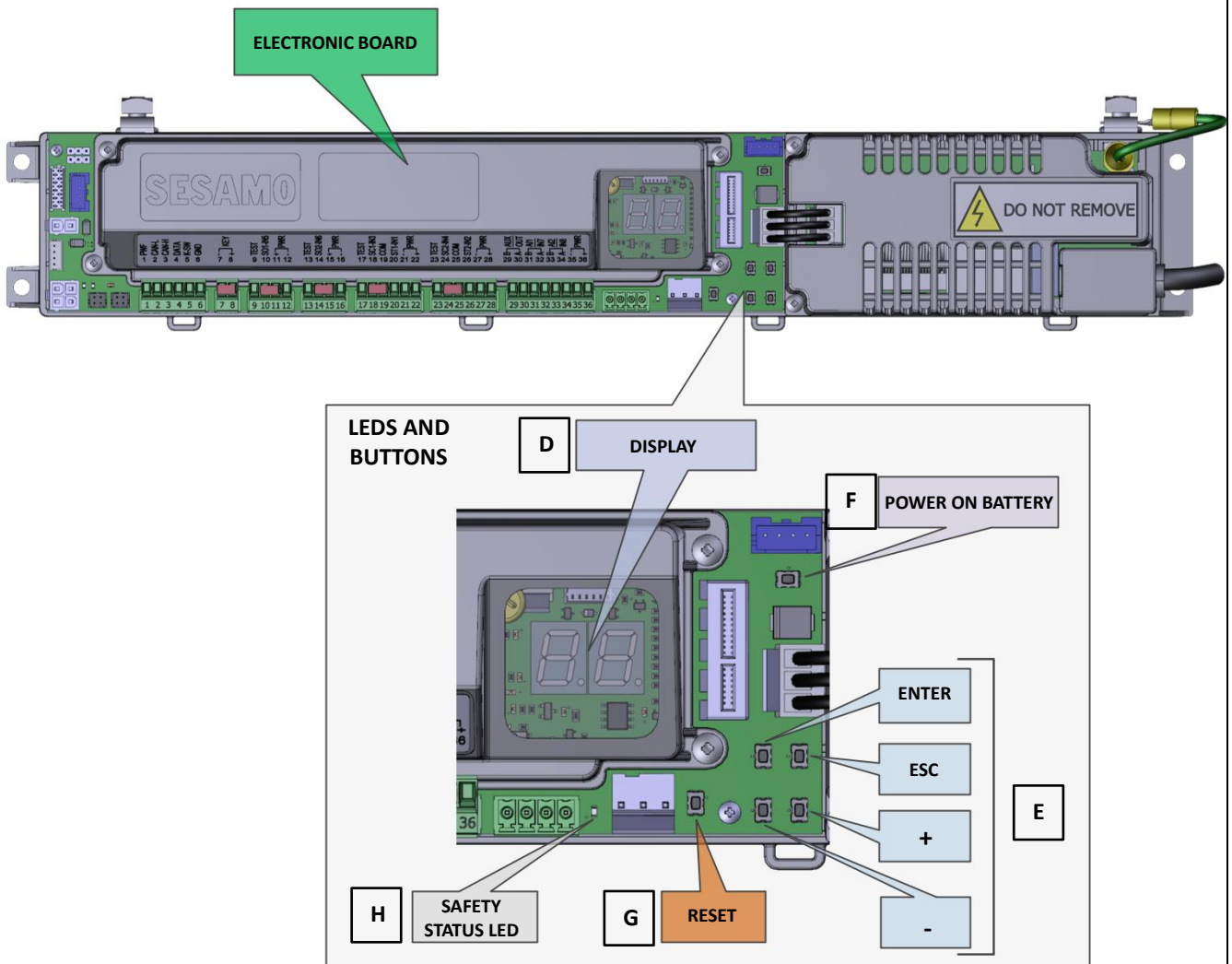

POWERCORE LEDs and Buttons

HINT	DESCRIPTION	NOTES						
D	Display	Door status information display and parameter modification management.						
E	Function Buttons	Selection and edit buttons Parameters. The ENTER button commands a door opening.						
F	Power ON Battery	Button used to turn on the control unit using the batteries if present and correctly connected.						
G	RESET button	Reset of the control panel and powered devices. It allows the control unit to be switched off if it is powered only by batteries.						
H	Safety Status LED	The LED lights up to indicate that at least one of the connected safety sensors is engaged or in supervisory error, it also signals the test status of the sensors:						
		<table border="1"> <thead> <tr> <th>Test status (Ch. 5.3, ID. 47)</th> <th>Description</th> </tr> </thead> <tbody> <tr> <td>TEST SAFE OPEN = ON TEST SAFE CLOSE = ON</td> <td>At the end of the opening cycle, 2 LED flashes indicate tests on SAFE OPEN and SAFE CLOSE; At the end of the closing cycle, 1 LED flash indicates SAFE OPEN test;</td> </tr> <tr> <td>TEST SAFE OPEN = OFF TEST SAFE CLOSE = ON</td> <td>At the end of the opening cycle, 1 LED flash indicates a test on SAFE CLOSE; At the end of the closing cycle, no flashing;</td> </tr> </tbody> </table>	Test status (Ch. 5.3, ID. 47)	Description	TEST SAFE OPEN = ON TEST SAFE CLOSE = ON	At the end of the opening cycle, 2 LED flashes indicate tests on SAFE OPEN and SAFE CLOSE; At the end of the closing cycle, 1 LED flash indicates SAFE OPEN test;	TEST SAFE OPEN = OFF TEST SAFE CLOSE = ON	At the end of the opening cycle, 1 LED flash indicates a test on SAFE CLOSE; At the end of the closing cycle, no flashing;
		Test status (Ch. 5.3, ID. 47)	Description					
TEST SAFE OPEN = ON TEST SAFE CLOSE = ON	At the end of the opening cycle, 2 LED flashes indicate tests on SAFE OPEN and SAFE CLOSE; At the end of the closing cycle, 1 LED flash indicates SAFE OPEN test;							
TEST SAFE OPEN = OFF TEST SAFE CLOSE = ON	At the end of the opening cycle, 1 LED flash indicates a test on SAFE CLOSE; At the end of the closing cycle, no flashing;							

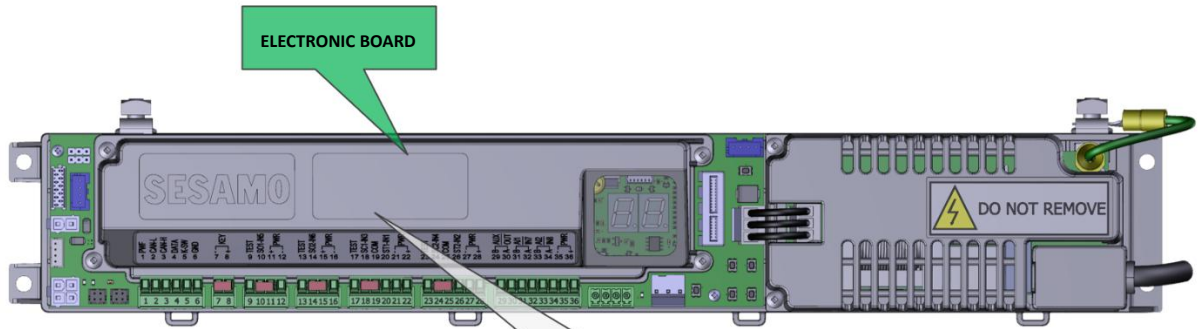

CONNECTORS

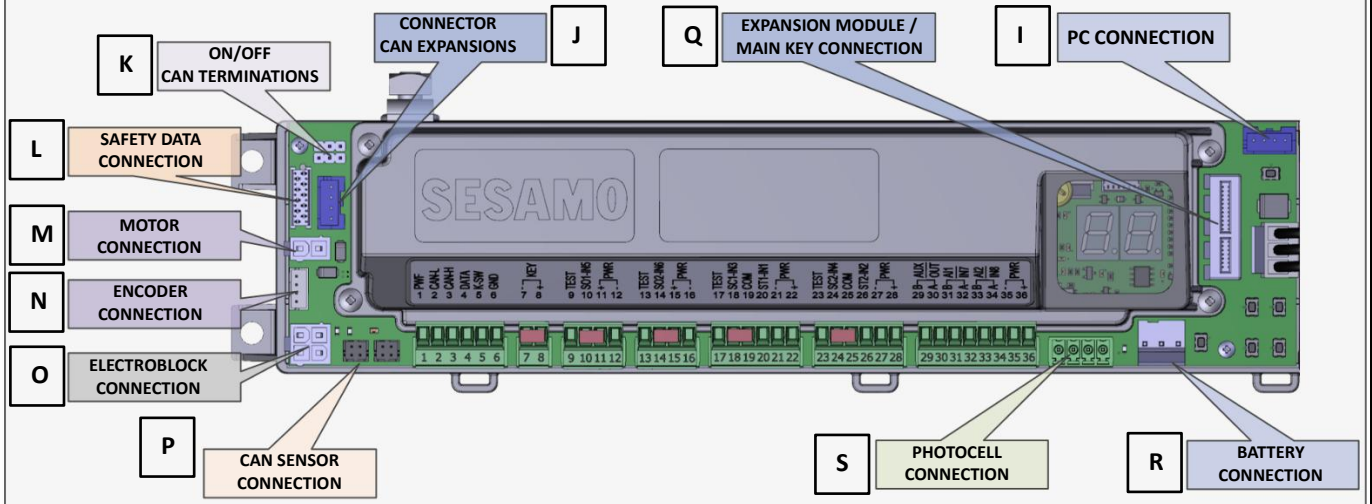

POWERCORE Connectors

INDEX	DESCRIPTION	NOTES
I	PC connector	Reserved for internal use Sesamo.
J	CAN Expansions Connector	Predisposition for expansions via CAN.
K	ON/OFF Terminations	Termination jumpers for communication CAN expansions or ER140 module.
L	Security Card Connection	Interface connector with ER140 safety management card.
M	Motor connector	-
N	Encoder Connector	-
O	Electric lock connector	-
P	CAN Sensor Connectors	Provision for safety sensor connection on CANopen
Q	Expansion Module Connector	Expansion module connection (e.g. IOpen) or MainKey for field reprogramming
R	Battery Connector	Connection of Lead or NiMH batteries
S	Photocell connector	-

4. POWERCORE CONTROL MODULE CONNECTIONS





WARNING RISK OF ELECTROCUTION

Individual devices for all operating phases:



List of equipment needed:

	Size: 0.8
	-

4.1. QUICK-CONNECTION PERIPHERALS

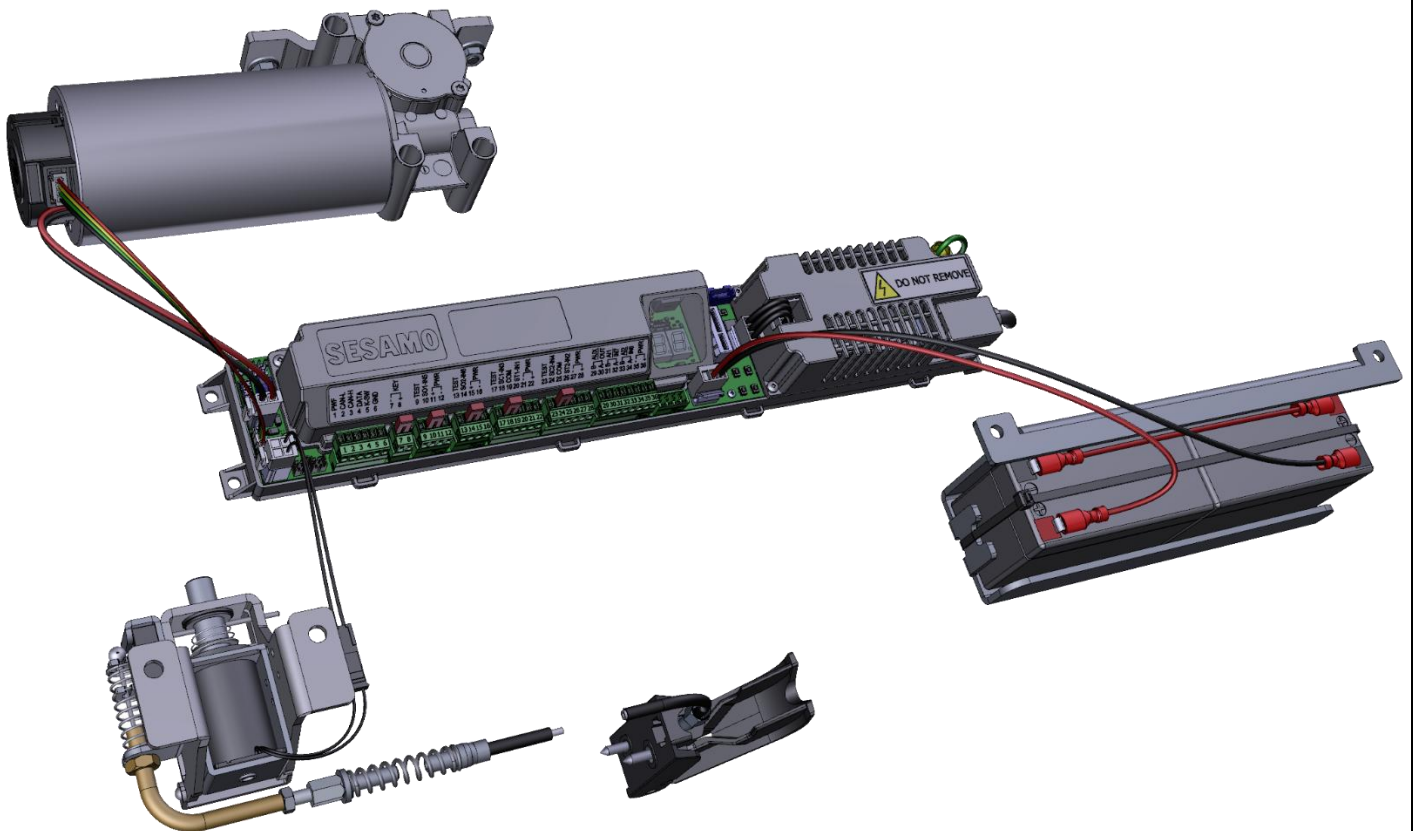

Connecting or disconnecting any device must be done with the
POWER DISCONNECTED

4.1.1. MOTOR AND ENCODER CONNECTION

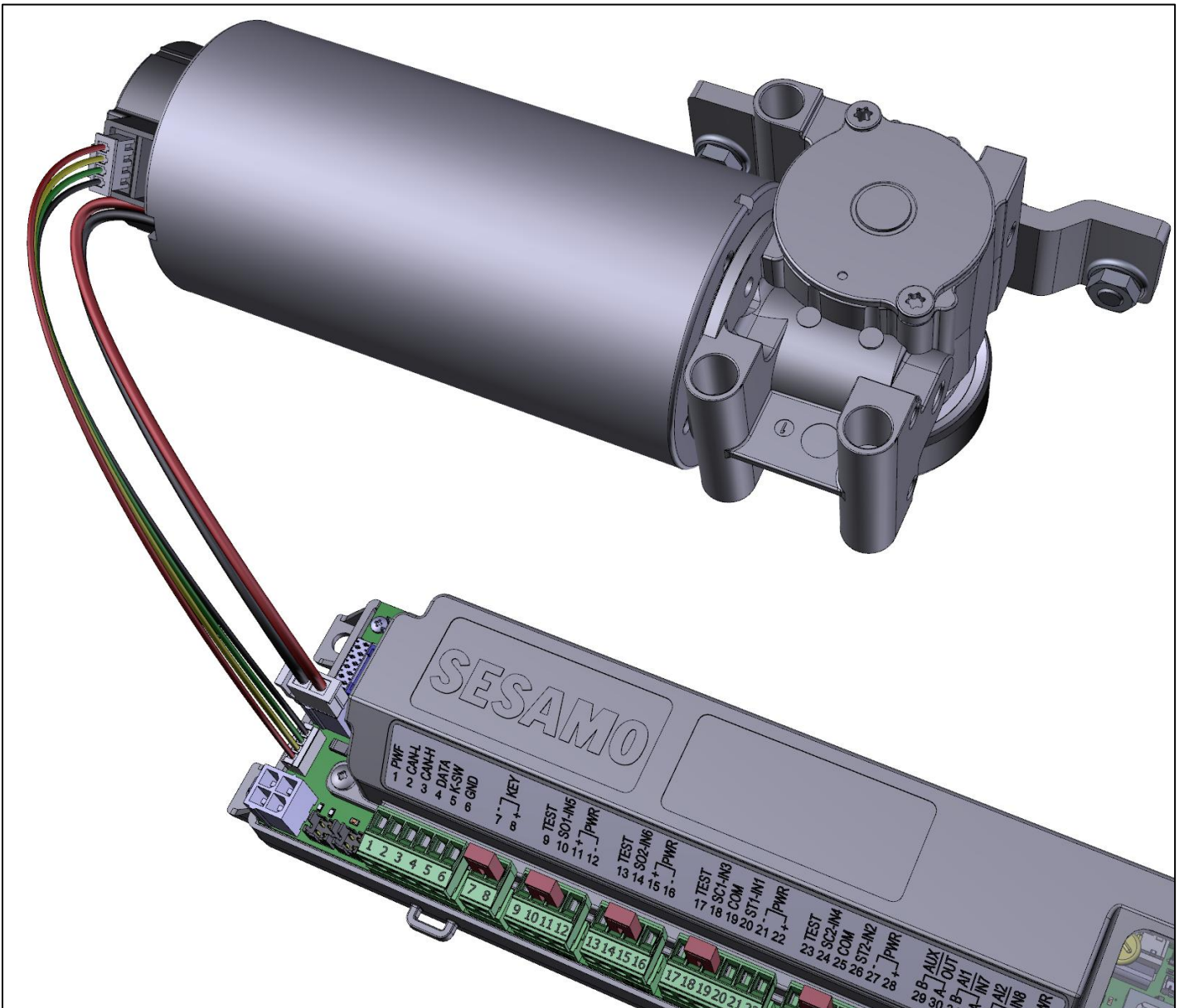
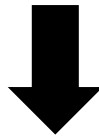
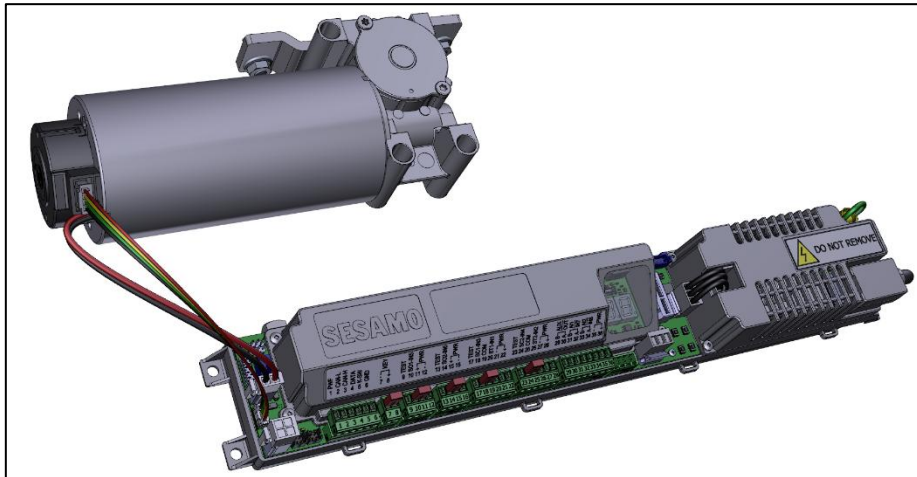

4.1.2. ELECTRIC LOCK CONNECTION

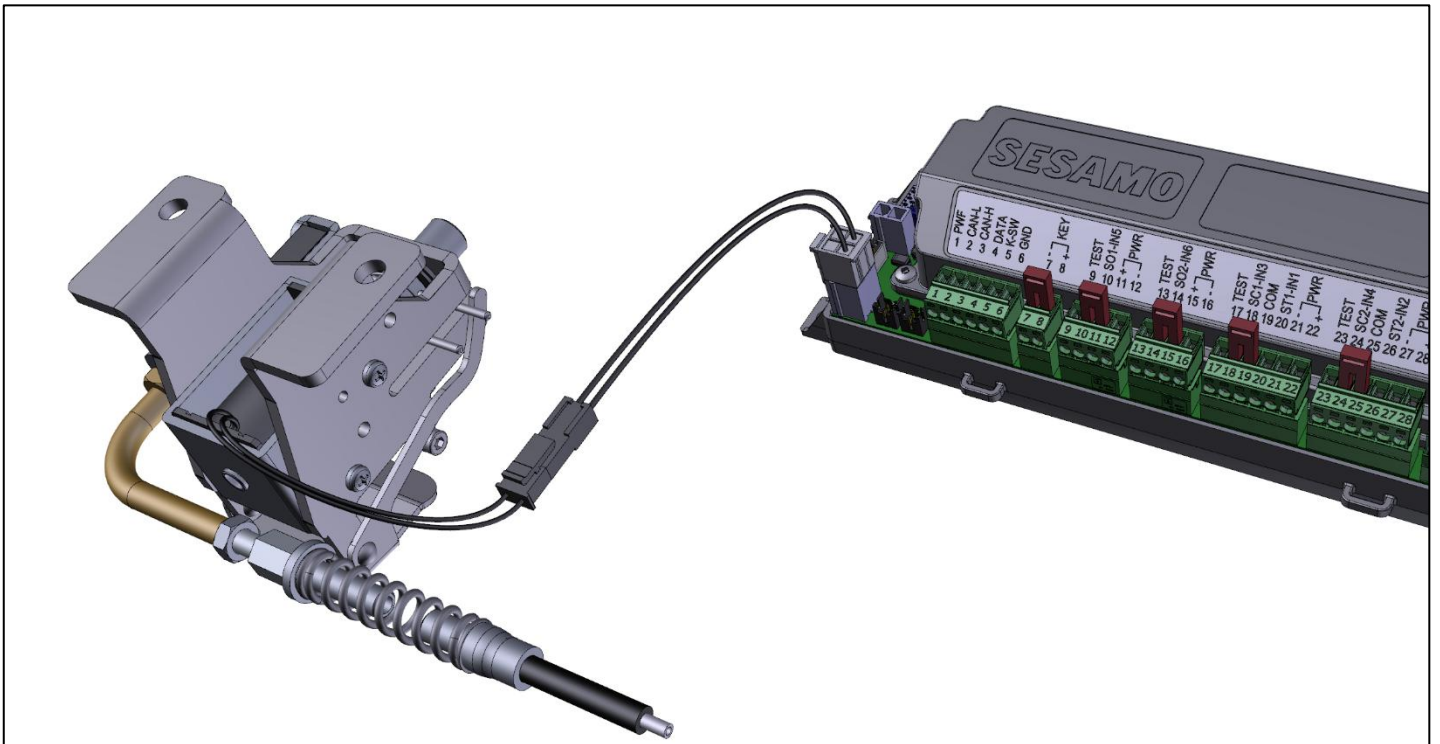
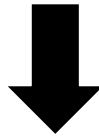
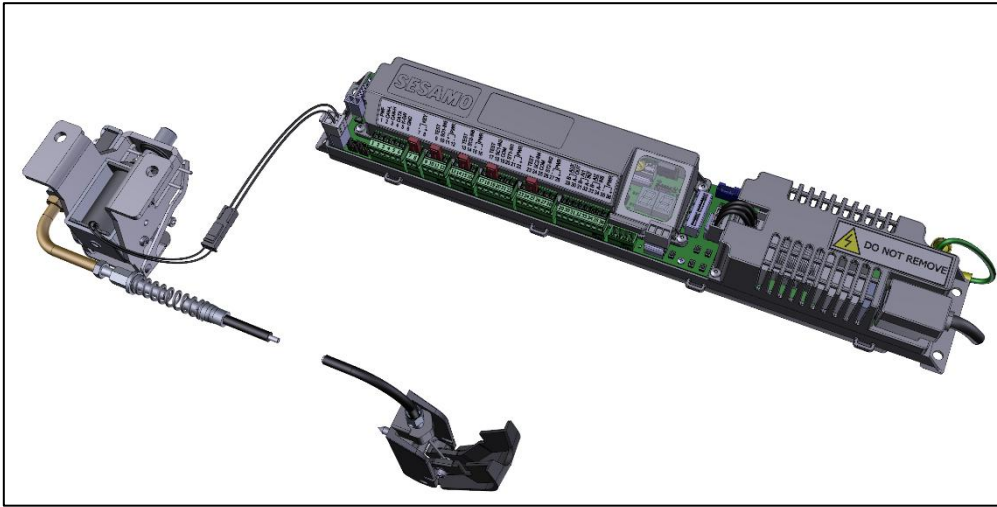

4.1.3. CONNECTING LEAD-ACID BATTERIES

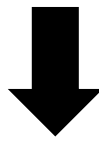
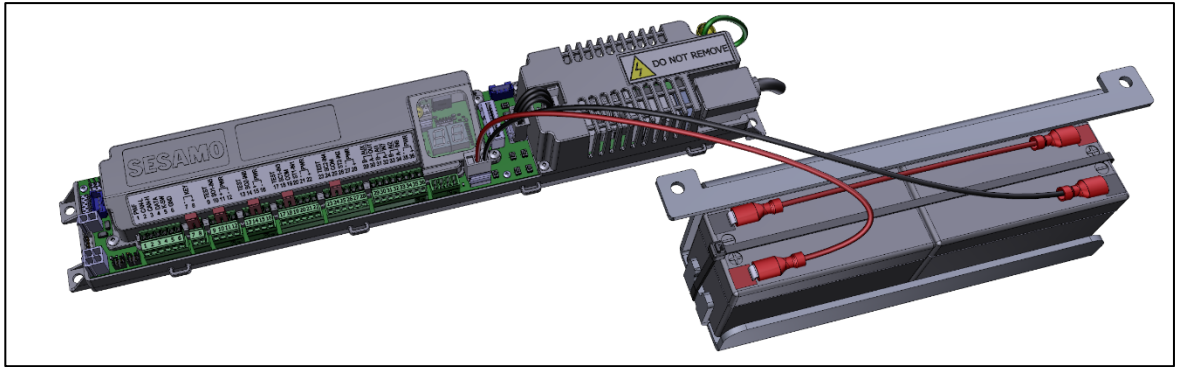

4.1.4. CONNECTING NIMH BATTERIES

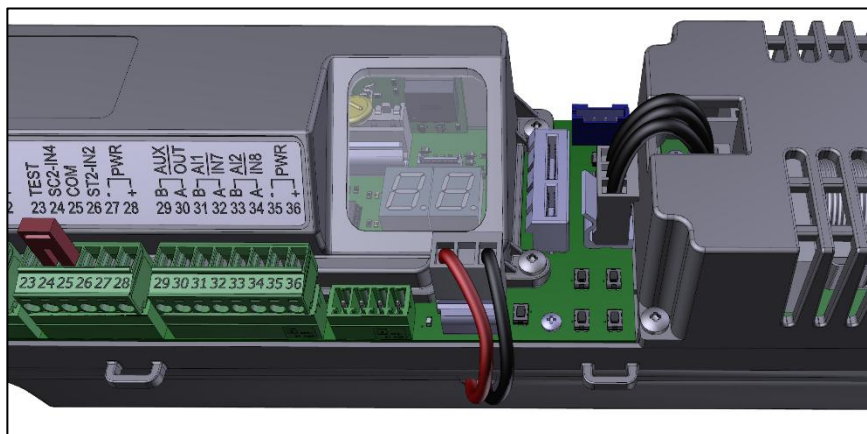
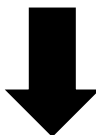
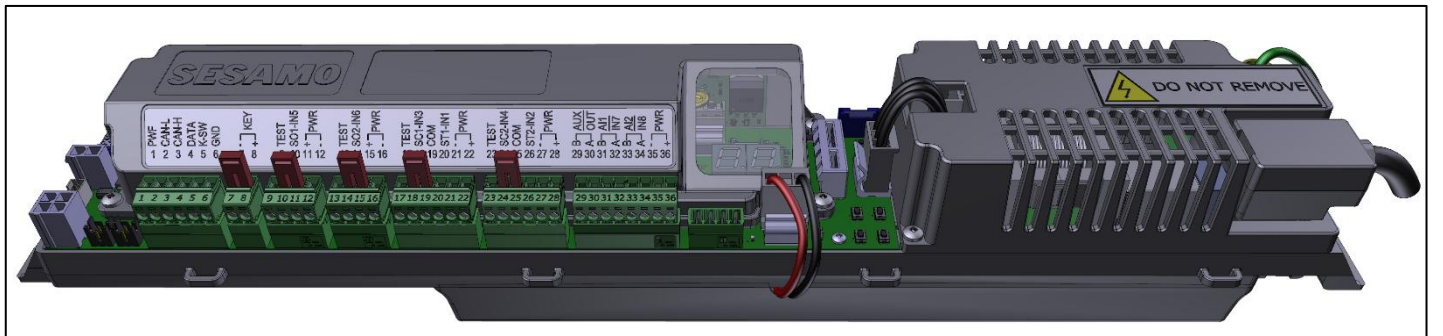
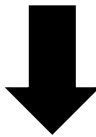
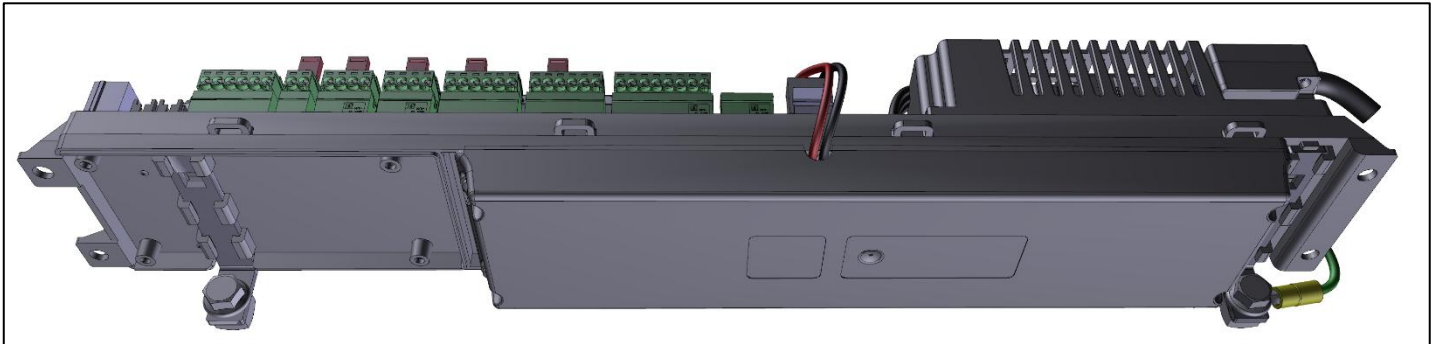
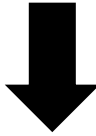
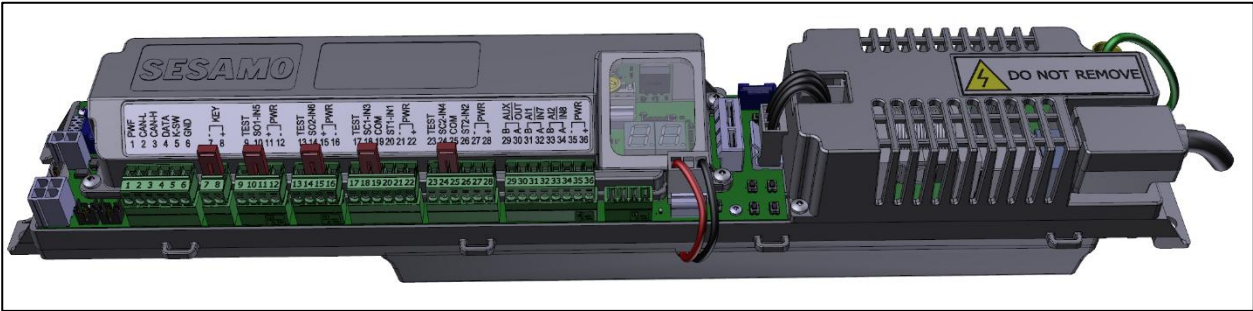

4.2. LEECTRONIC BOARD CONNECTORS

Finished entrance image with sensor workspaces, complete configuration:

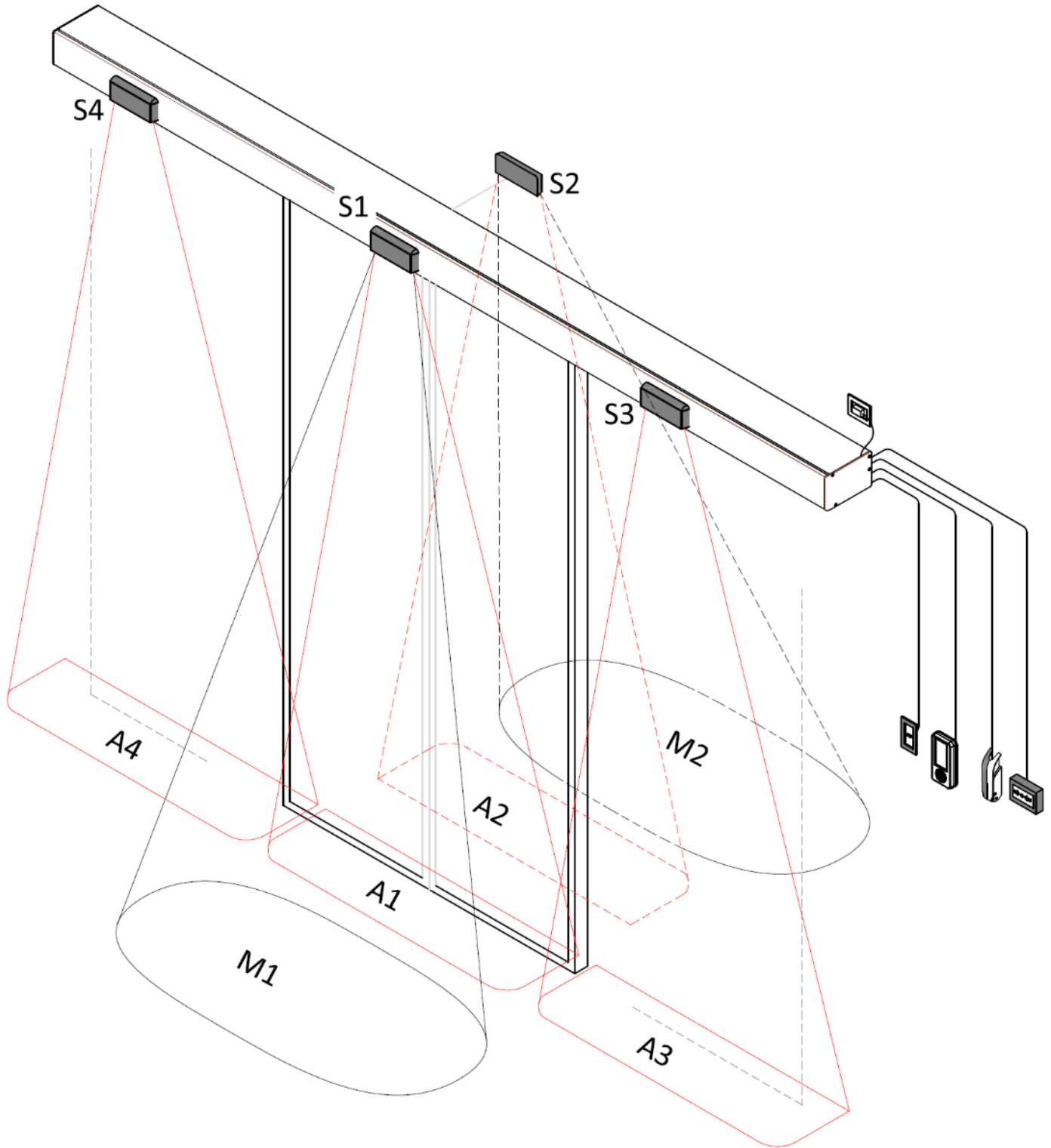

Connect all the components of the automatic entrance with electrical cables of appropriate cross-section, respecting the indications in the following table:

Electronic board connectors







IMAGE	N.	REF.	DEFAULT	DESCRIPTION	NOTES
J10 	1	PWF	(+)	Positive power supply (*)	PWF Digidor/Icon RotoK3/RotoK5 Selector
	2	CAN-L		CAN communication	
	3	CAN-H		CAN communication	
	4	DATA		One Wire Serial Communication	DATA selector Digidor/Icon
	5	K-SW		Logic Selector	RotoK3/RotoK5 rotary selector switch
	6	GND	(-)	Negative power supply.	GND selector Digidor/Icon
J22 	7	KEY -	NC	KEY , Lock control Night operation/locking.	
	8	KEY +			
J11 	9	TEST		Control of the test circuit of the safety sensors in the opening S3/S4.	NPN contact with maximum current 50mA
	10	SO1 – IN5	NC	SAFE OPEN 1 , safety sensor on the right side of the A3 zone	See image at the beginning of the chapter – S3 sensor
	11	PWR+	(+)	Positive power supply (*)	For safety sensor on the right side opening.
	12	PWR -	(-)	Negative power supply	
J13 	13	TEST		Negative test circuit of the safety sensors in the opening S3/S4.	NPN contact with maximum current 50mA
	14	SO2 – IN6	NC	SAFE OPEN 2 , safety sensor on the opening left side of the A4 zone	See image at the beginning of the chapter – S4 sensor
	15	PWR+	(+)	Positive power supply (*)	For safety sensor on left side opening
	16	PWR -	(-)	Negative power supply	
J12 	17	TEST		Control of the test circuit of the S1/S2 internal and external locking safety sensors	NPN contact with maximum current 50mA
	18	SC1 – IN3	NC	SAFE CLOSE 1 , safety sensor when closing outside zone A2	See image at the beginning of the chapter – S2 sensor
	19	WITH		Common Signal for Input: 18, 20	
	20	ST1 – IN1	NO	START 1 , external side opening control.	See image at the beginning of the chapter – M2 sensor
	21	PWR -	(-)	Negative power supply	For external opening and closing control sensor;
	22	PWR+	(+)	Positive power supply (*)	

IMAGE	N.	REF.	DEFAULT	DESCRIPTION	NOTE
 <p>J14</p>	23	TEST		Control of the test circuit of the S1/S2 internal and external locking safety sensors	NPN contact with maximum current 50mA
	24	SC2 – IN4	NC	SAFE CLOSE 2 , safety sensor in internal closing zone A1	See image at the beginning of the chapter – S1 sensor
	25	WITH		Common signal for input: 25, 27	
	26	ST2 – IN2	NO	START 2 , opening control on the inside.	See image at the beginning of the chapter – M1 sensor
	27	PWR -	(-)	Negative power supply	For opening control sensor and external closing safety.
	28	PWR+	(+)	Positive power supply (*)	
 <p>J21</p>	29	AUX OUT (B)		Auxiliary Output Optoisolated Relay	See Chapter 4.3.6 for connection examples
	30	AUX OUT (A)			
	31	AI1 – IN7 (B)		Auxiliary Input 1 Optoisolated	See Chapter 4.3.7 for connection examples
	32	AI1 – IN7 (A)			
	33	AI2 – IN8 (B)		Auxiliary Input 2 Optoisolated	
	34	AI2 – IN8 (A)			
	35	PWR -	(-)	Negative power supply	For accessories
	36	PWR+	(+)	Positive power supply (*)	

(*) Power supply voltage 12Vdc maximum current that can be supplied by the control unit 500mA.



Respect the connections in the table, respect the polarities where necessary, do not connect users with absorptions higher than the limits in the table. Remove the jumper wires between all the clamps used. Otherwise, an important safety function may be compromised and the automatic movement of the leaves could cause serious damage to property or people with a risk of fatal injury. If the risk analysis shows the need to protect the A3/A4 zone with physical barriers, then the jumpers between 10/11 and 14/15 should not be removed as the S3/S4 sensors cannot be installed.



The use of S3/S4 sensors may compromise the regulatory requirement regarding the maximum permissible opening time for 80% of the useful passage space

4.3. SENSOR AND PERIPHERAL CONNECTION DIAGRAMS

4.3.1. SENSORS

Detection with dual technology sensors at the input and output. The following sensors can be used:

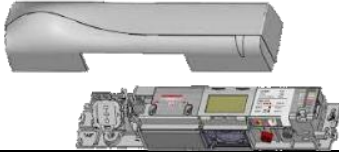
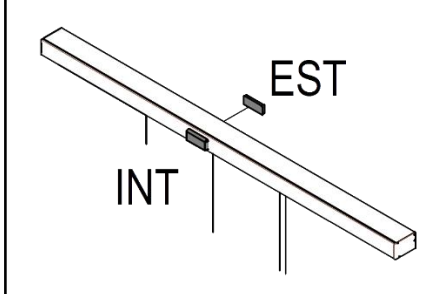
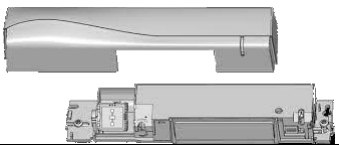
<p>IXIO DT1 – Code PF11.64 (INTERNAL SENSOR – S1) (EXTERNAL SENSOR – S2)</p>		
<p>VIO DT1 / 2 – Cod. PF11.63 (INTERNAL SENSOR – S1) (EXTERNAL SENSOR – S2)</p>		

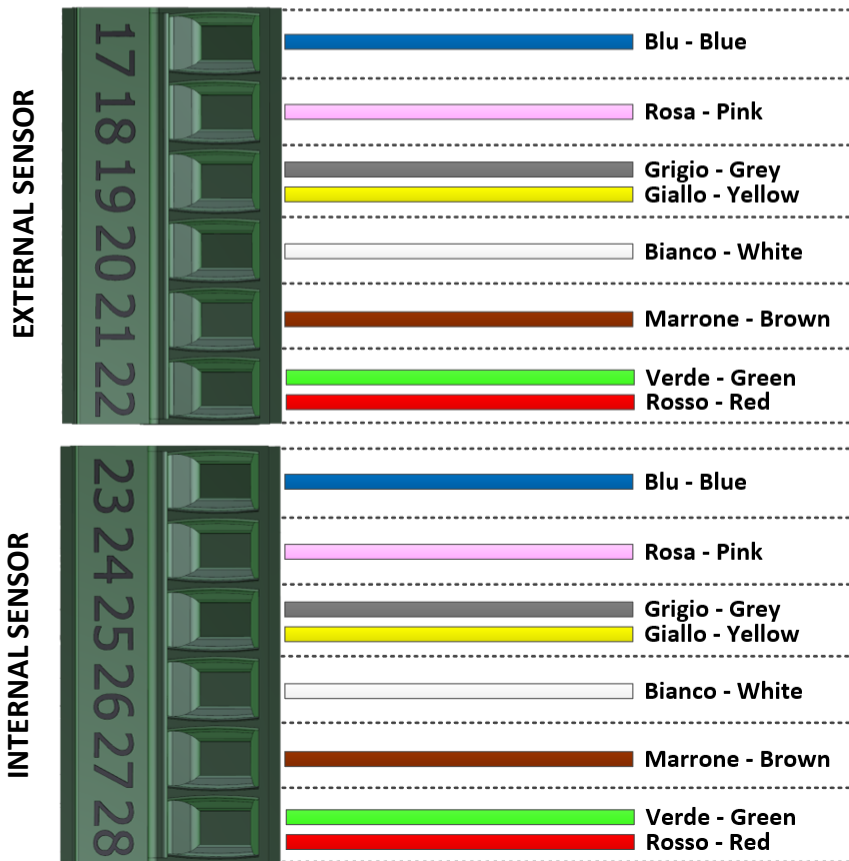
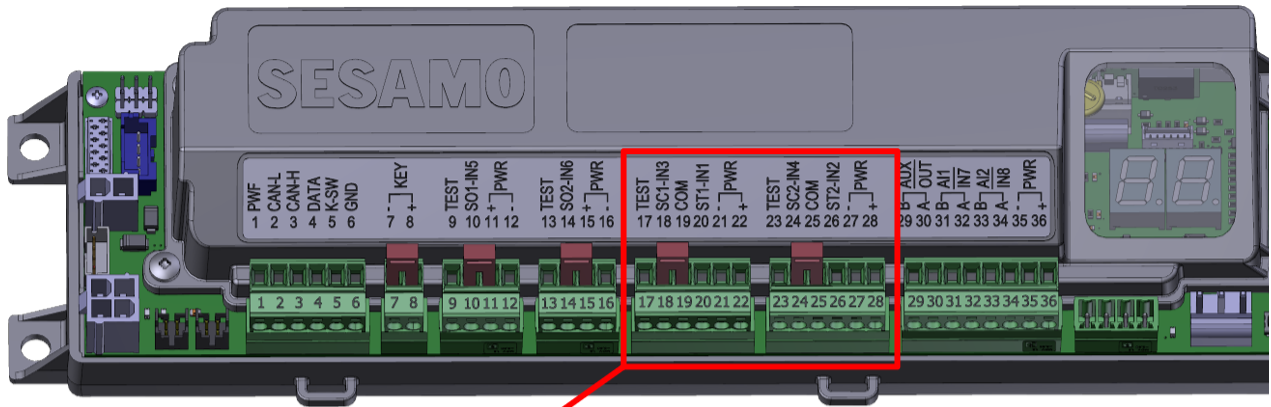

Sensor wiring products up to 2025

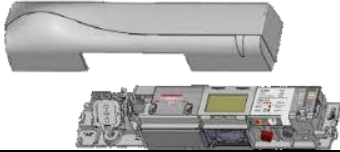
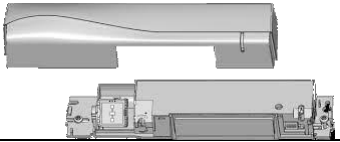

Remove the jumper wires on the connectors before connecting the sensor wires

<p>IXIO DT1 – Code PF11.64 (INTERNAL SENSOR – S1) (EXTERNAL SENSOR – S2)</p>	
<p>VIO DT1 / 2 – Cod. PF11.63 (INTERNAL SENSOR – S1) (EXTERNAL SENSOR – S2)</p>	

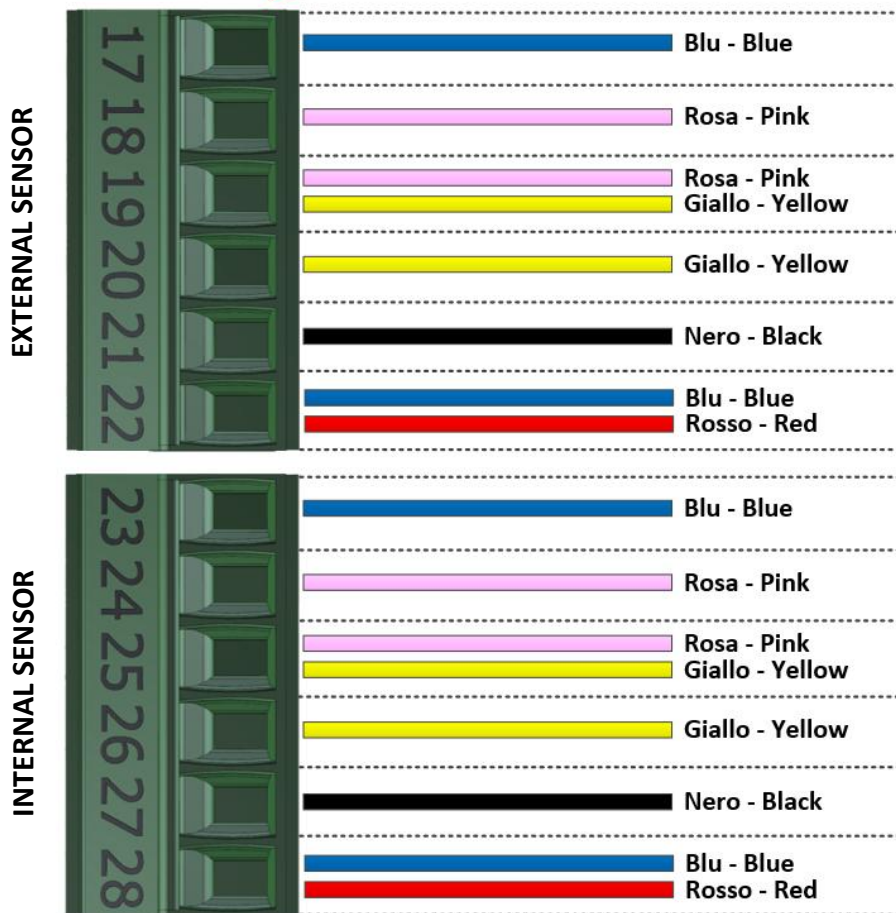
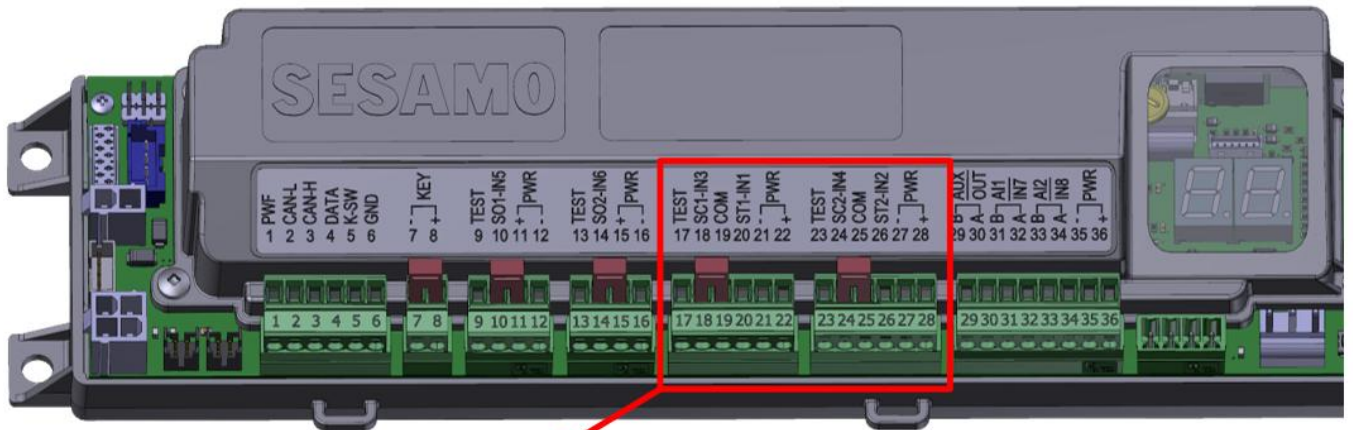
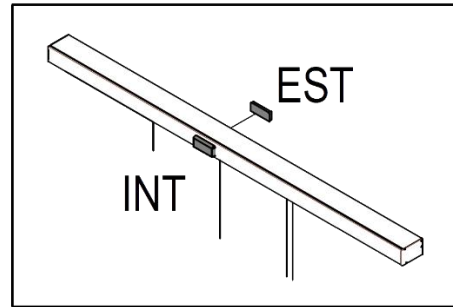

Sensor wiring products from 2025 onwards



Remove the jumper wires on the connectors before connecting the sensor wires

Axis T – Cod. PF11.58
 (INTERNAL SENSOR – S1)
 (EXTERNAL SENSOR – S2)

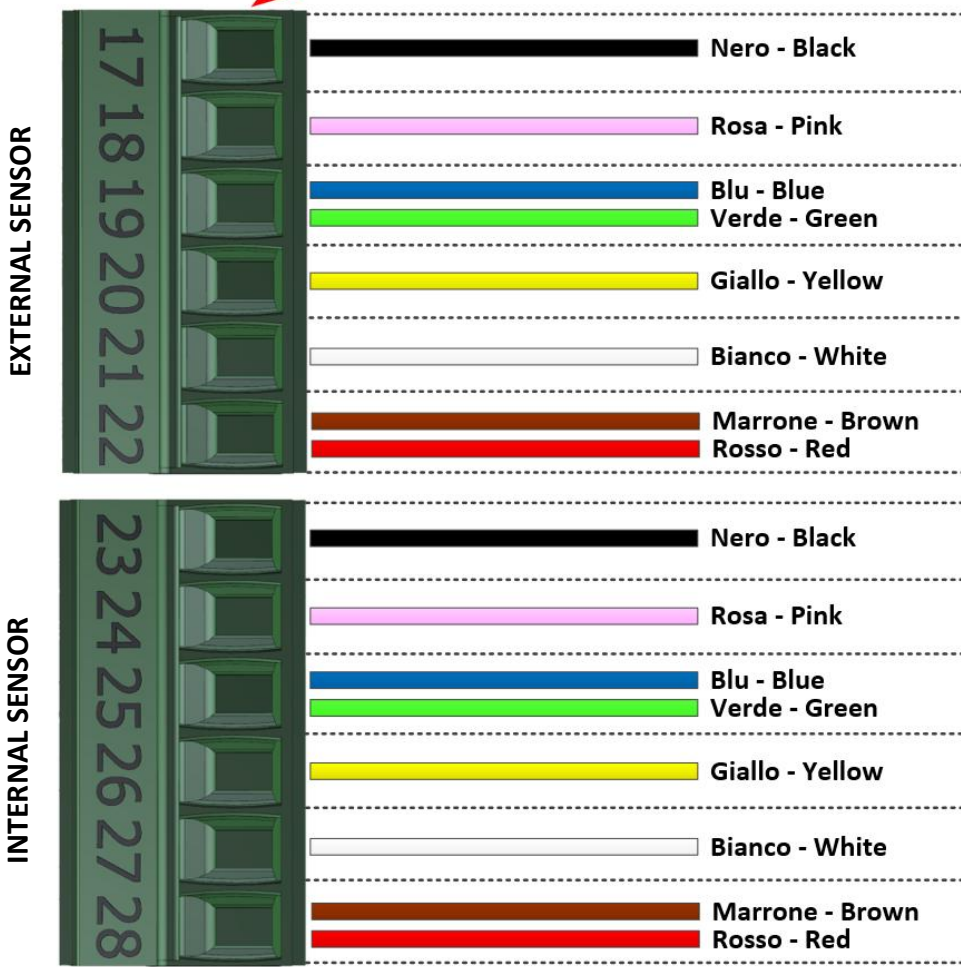
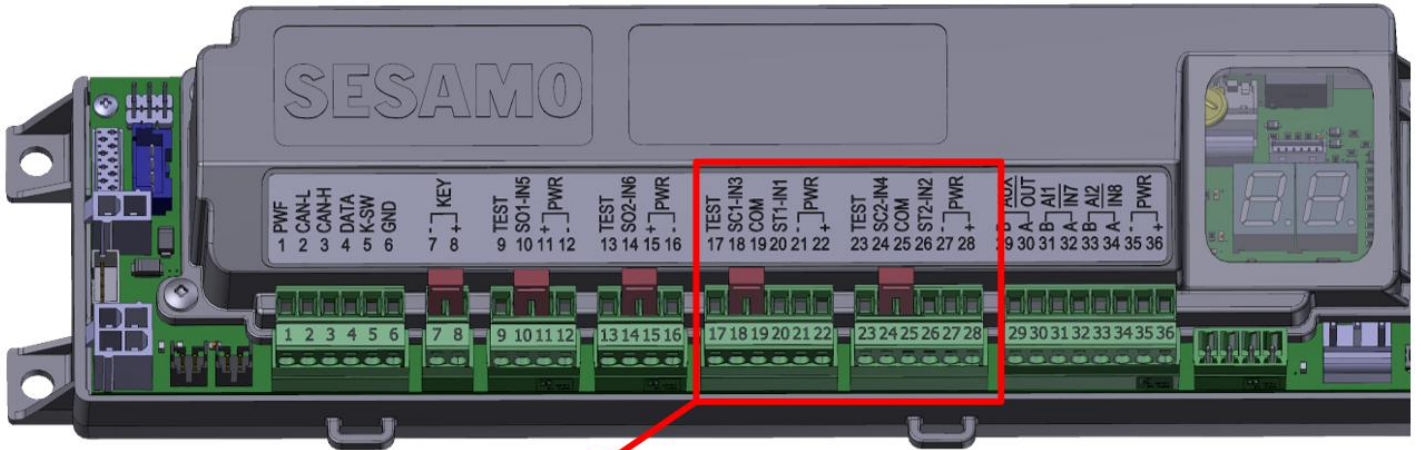
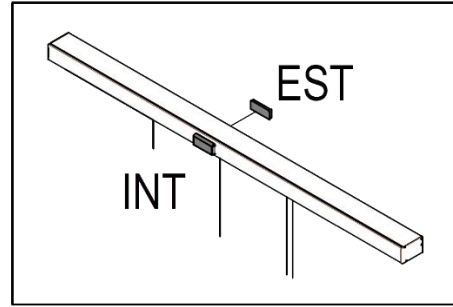

Remove the jumper wires on the connectors before connecting the sensor wires

Detection with two infrared sensors at the output. The following sensors can be used:

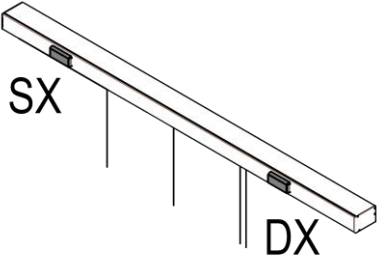
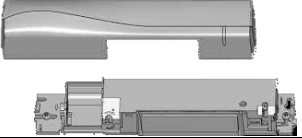
<p>IXIO ST – Cod. PF11.70 (LEFT SENSOR – S4) (RIGHT SENSOR – S3)</p>		
<p>VIO ST – Cod. PF11.81 (LEFT SENSOR – S4) (RIGHT SENSOR – S3)</p>		

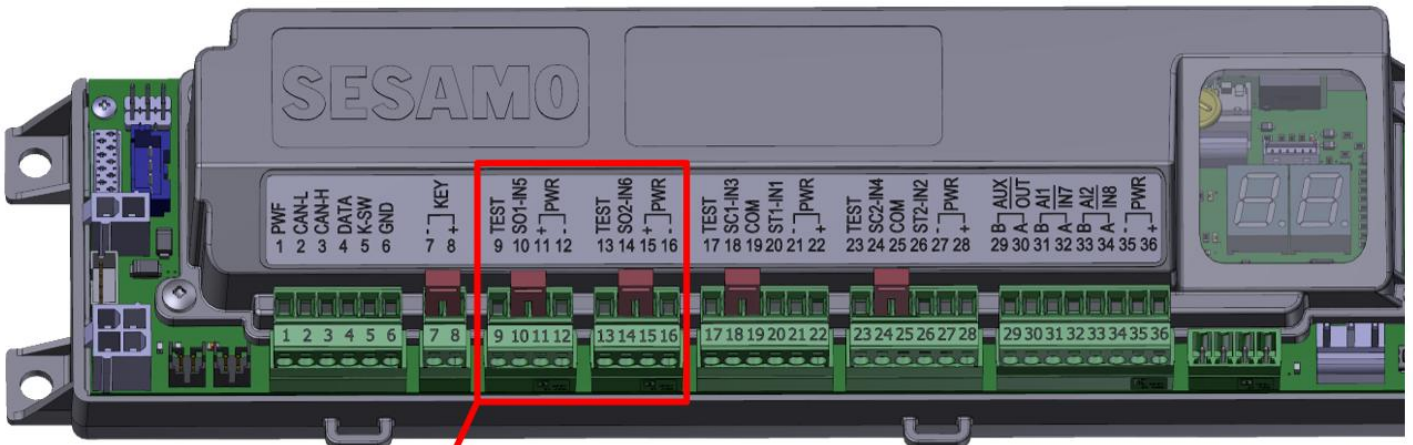

Sensor wiring products up to 2025



Remove the jumper wires on the connectors before connecting the sensor wires

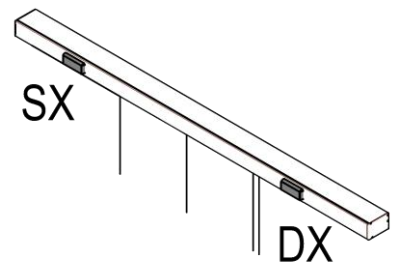
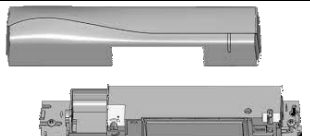

Note: The use of the S3/S4 sensors must be confirmed by the risk analysis. The functionality of the Safe Open inputs is defined by parameter 35 Chapter 5.3.

<p>IXIO ST – Cod. PF11.70 (LEFT SENSOR – S4) (RIGHT SENSOR – S3)</p>		
<p>VIO ST – Cod. PF11.81 (LEFT SENSOR – S4) (RIGHT SENSOR – S3)</p>		

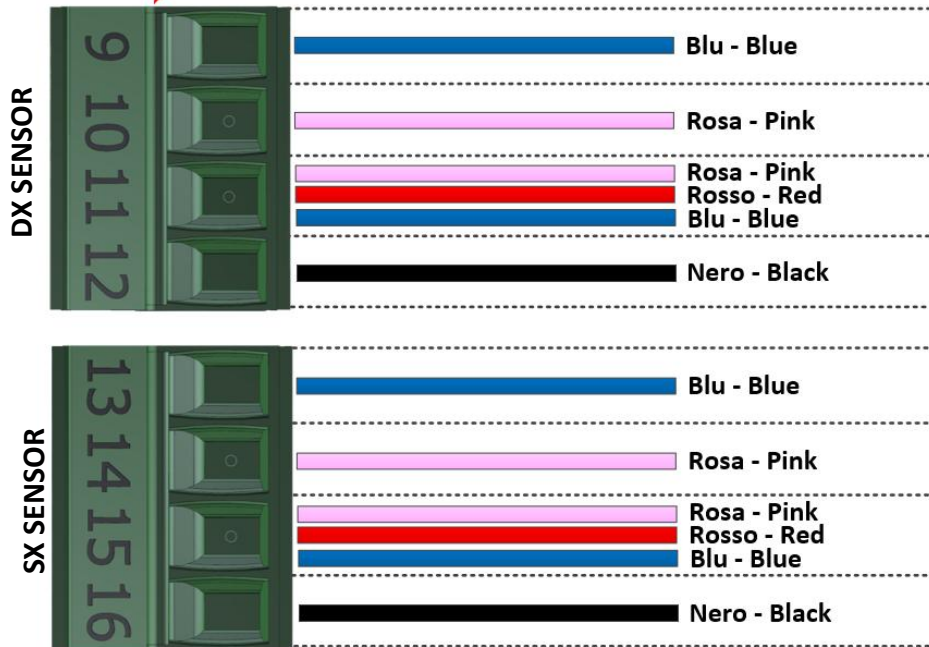
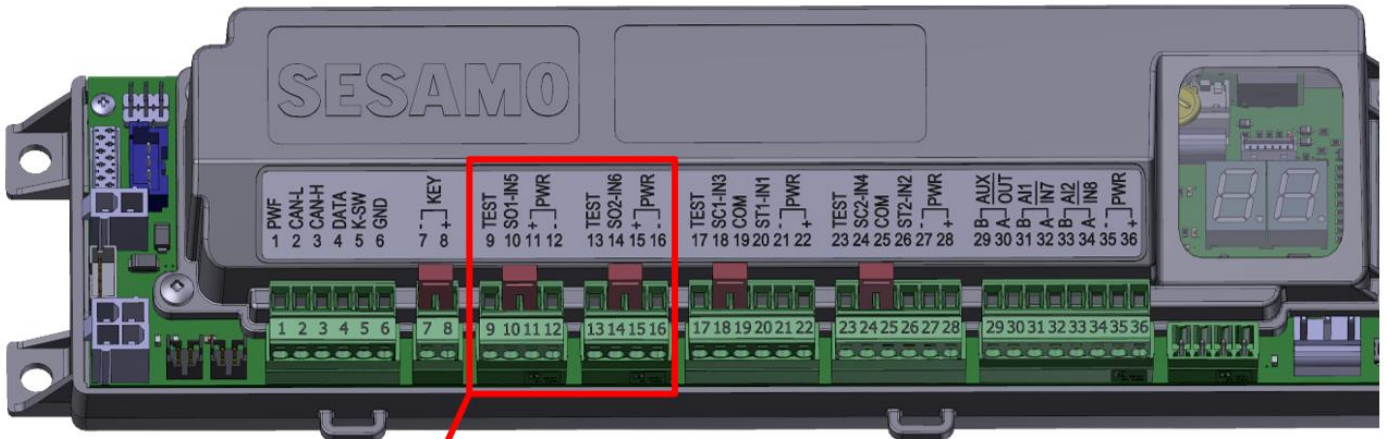

Sensor wiring products from 2025 onwards



Remove the jumper wires on the connectors before connecting the sensor wires



Note: The use of the S3/S4 sensors must be confirmed by the risk analysis. The functionality of the Safe Open inputs is defined by parameter 35 Chapter 5.3.

4.3.2. DIGIDOR connection diagram

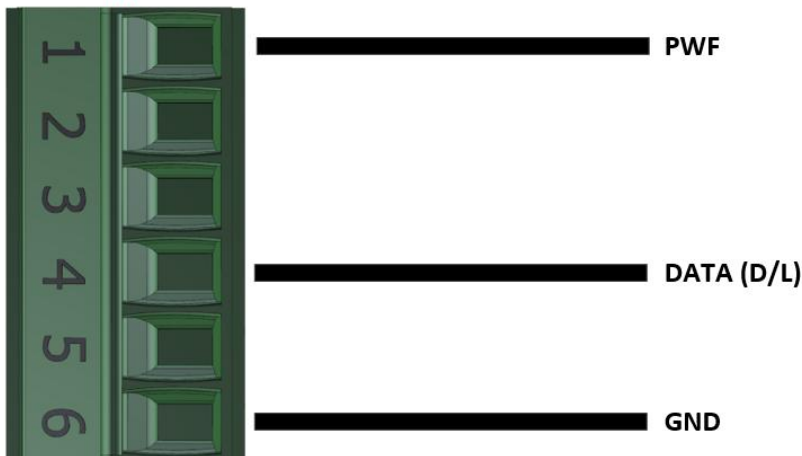
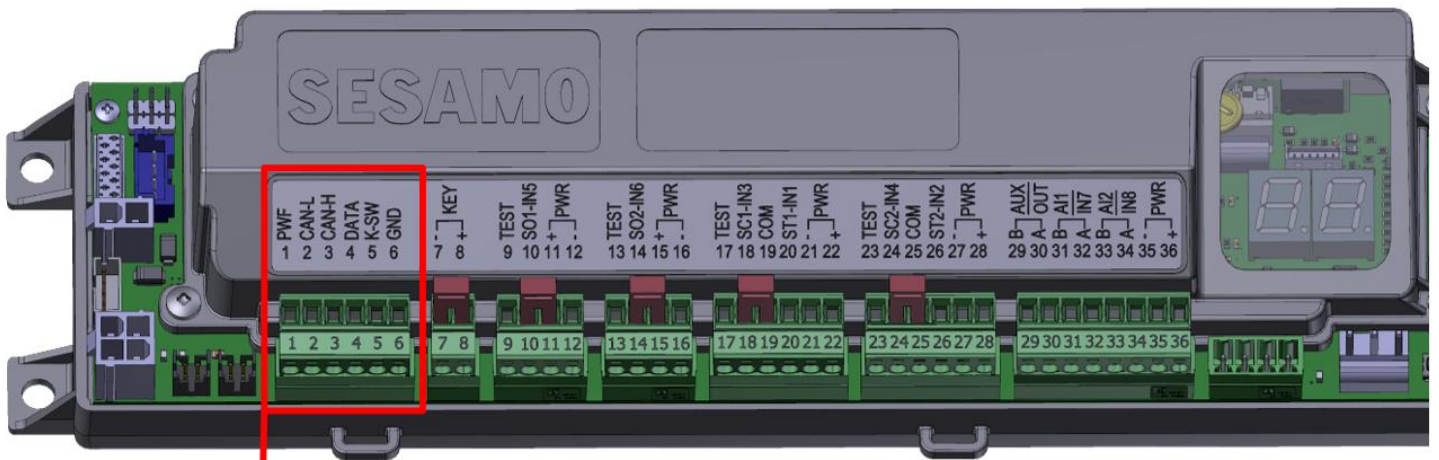
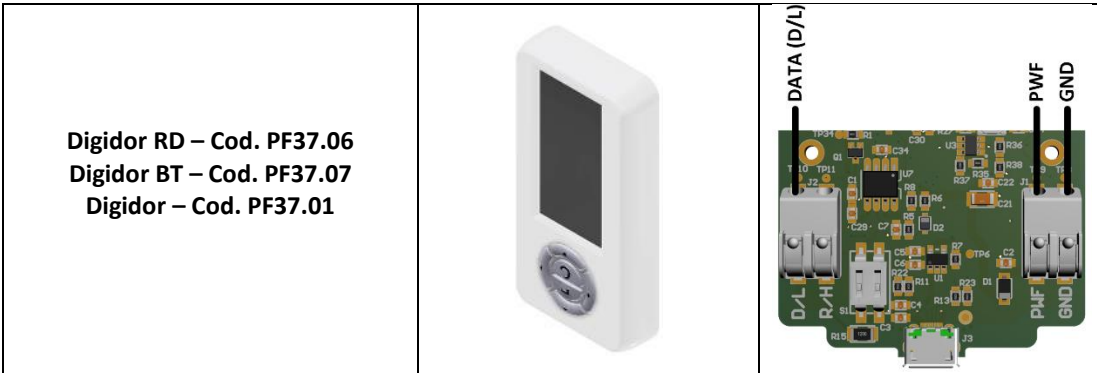

4.3.3. ICON Connection Diagram

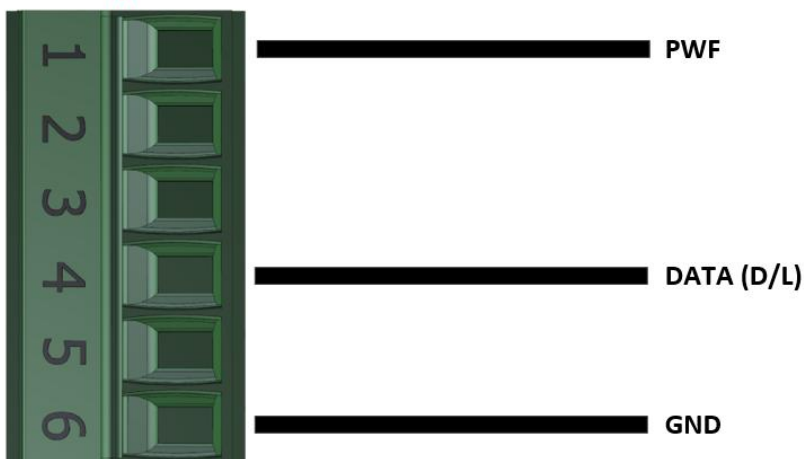
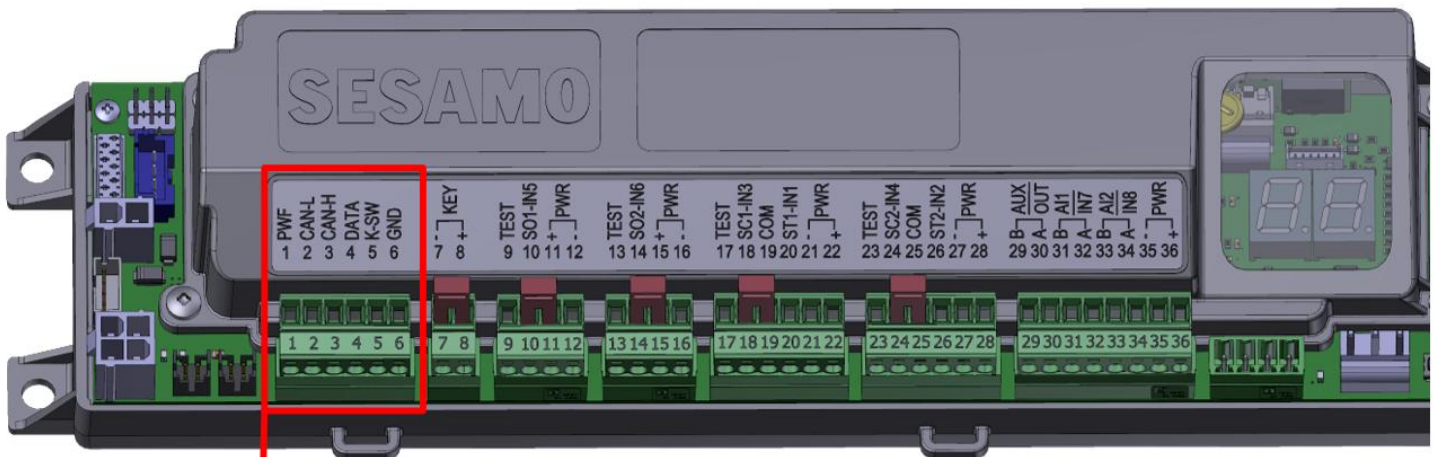

4.3.4. Roto K3/Roto K5 connection diagram

Roto K5 - Cod. PF37.05	
Roto K3 - Cod. PF37.03	
Roto M5 - Cod. PF37.08	

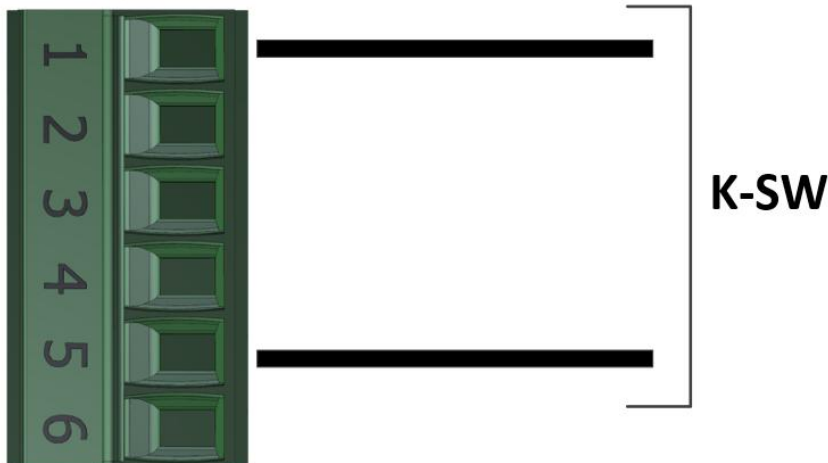
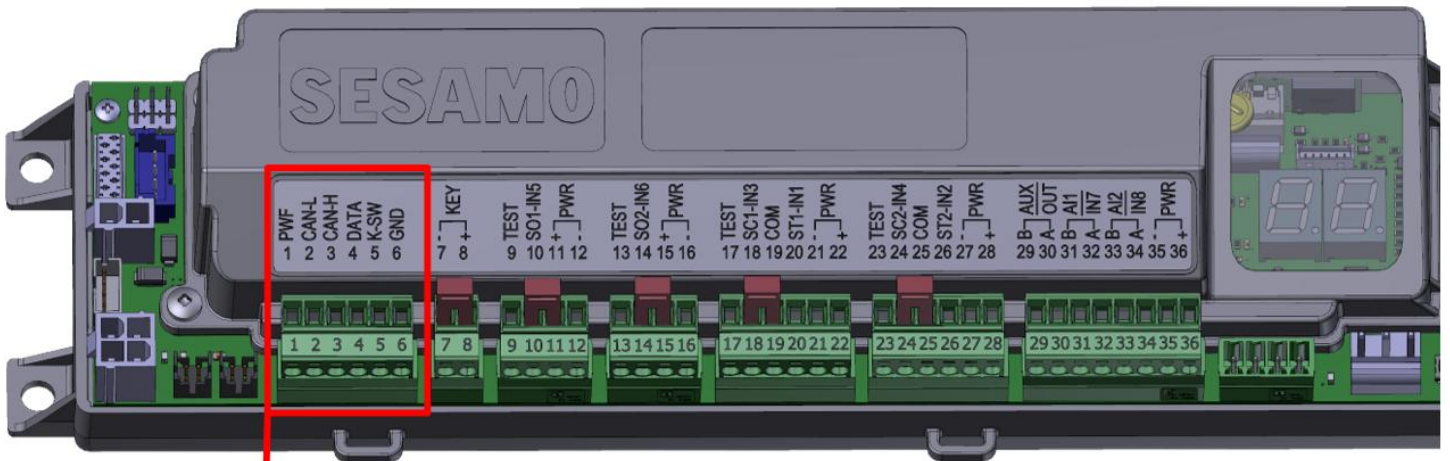

No polarity is required for the connection of the Rotary selector switch

4.3.5. External Key Contact connection diagram (OPTIONAL):

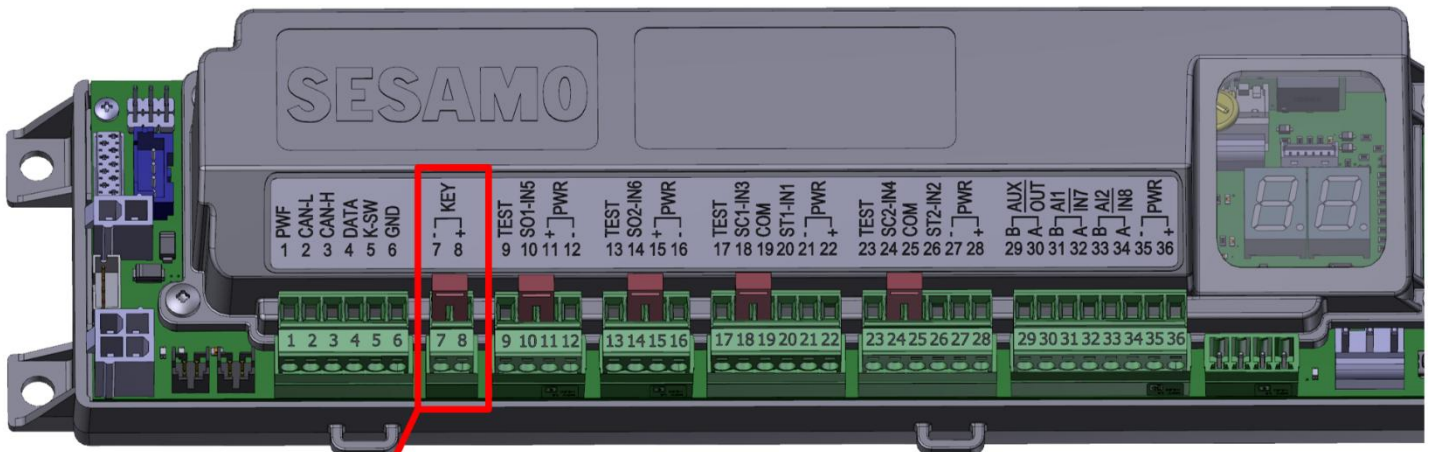

Remove the jumper on the connector before connecting the wires

Contact can be set as Bistable (default) or Monostable, see Parameter 32.

It is possible to define whether or not the activation of this contact causes the Door to open, see Parameter 32.

If not in use, leave the jumper between pins 7-8.

This contact takes precedence over the block selection on the Icon or Digidor Logic selector.

Deactivating this contact (Contact open if configured as NC) causes the door to close in "night" mode, in this condition:

- The control sensors are inhibited (it is possible to set an inhibit delay in order to guarantee the output, see Parameter 48).
- The electric lock, if present, is activated.
- Any mains failure or discharge of the batteries does not cause the doors to open, even if set with Parameter 33).
- The only possibility of opening the doors with the KEY contact disabled is through an input configured as Emergency Opening.

4.3.6. AUX-OUT connections

Opto isolated auxiliary output (30VDC - 100mA), configurable as signaling and polarity, see Parameters 17 and 29. In case the load exceeds the above limits an external relay board (PF11.52) must be used

External Relay Connection:

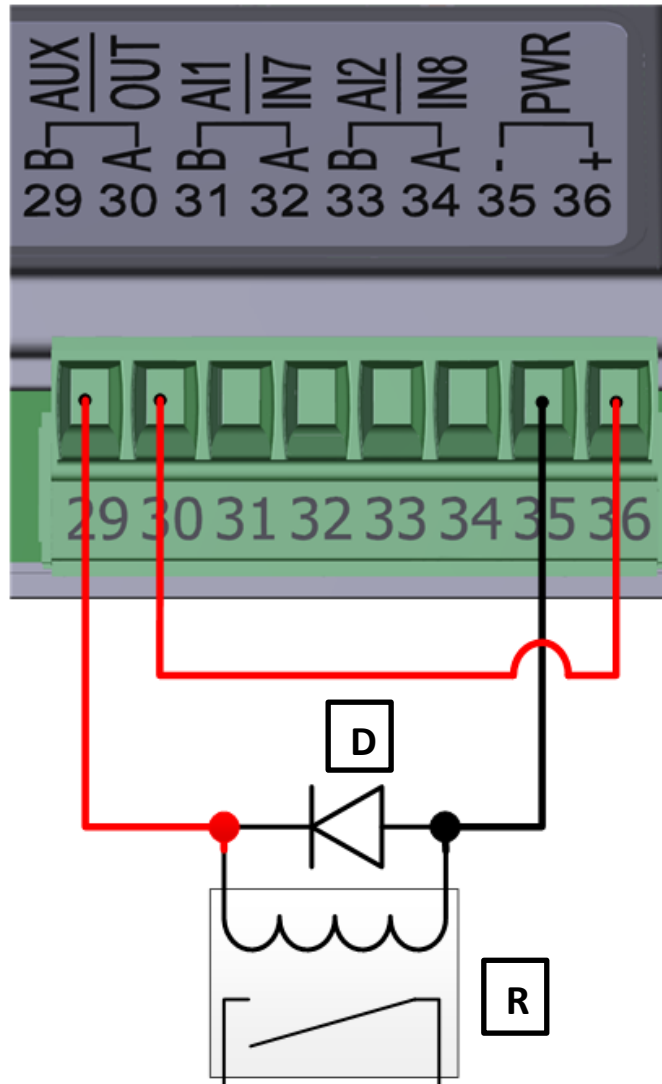

R = Relay with 12Vdc coil – 100mA MAX - D = Protection diode;



WARNING: when used with relays (or other coils) it is mandatory to insert the protection diode in the polarity shown in the figure.

4.3.7. AUX-IN connections

Opto isolated inputs configurable as Functionality and Polarity, see Parameters 15-16-26-27

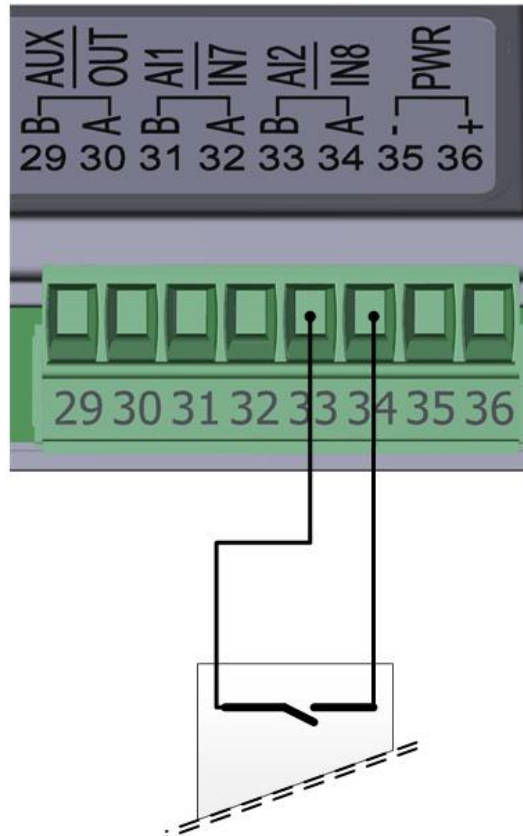
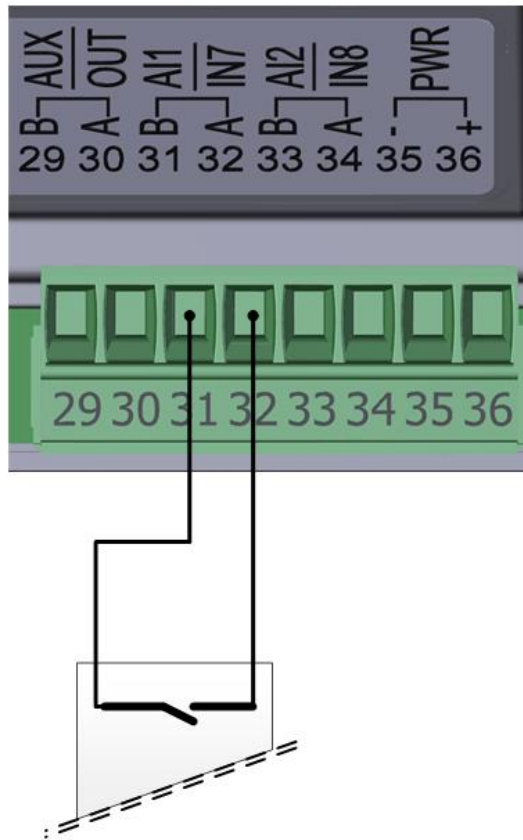

5. USER INTERFACE

The display and possible modification of the control panel parameters as well as the sending of some operational commands (Acquisition of the Door Parameters, Set to default, etc.) can take place:

- Via the Display + Keys user interface directly on the board.
- Via Digidor logic selector installed on the Door.
- Via App connected to the Digidor-BT selector installed on the Port.
- Via Digidor Selector connected via USB to the Icon Selector installed on the Port.

5.1. Display and Function Keys

Interaction with the control panel takes place via a double-digit 7-segment LED display and 4 function keys:

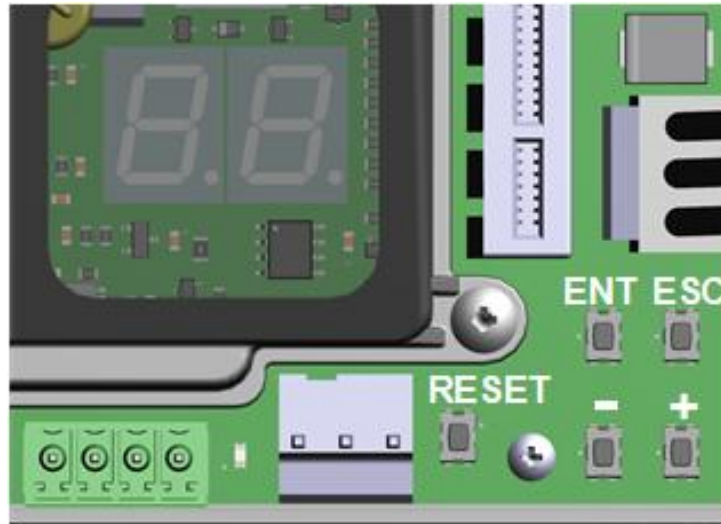

- The **+** and **-** keys are used to navigate the Menu and to change the parameters; pressing them continuously causes them to advance rapidly within the parameters and their value.
- The **ENT (ENTER)** key is used to enter the various menus of the parameters to be configured and to confirm the changes;
- The **ESC** key is used to go back without making changes to the selected parameter, when you exit the Main Menu with the ESC key all the changes made are saved. While saving on both digits of the Display, there is a clockwise rotation of the segments for a few seconds;

Navigate the Menu:

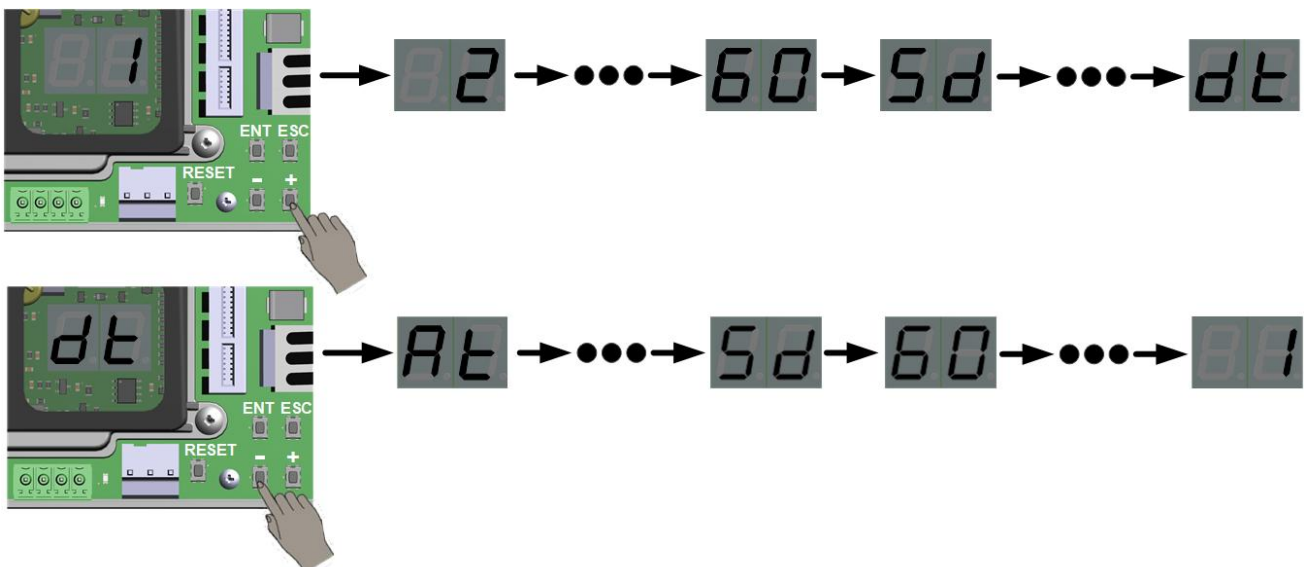

Example parameter 2 change:

Select parameter to edit

1

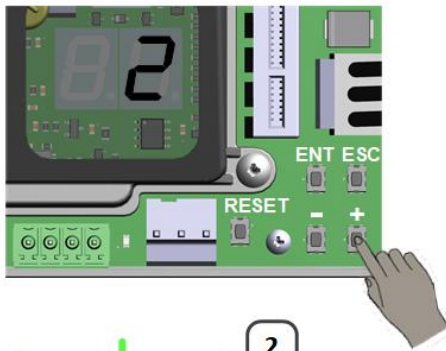

6

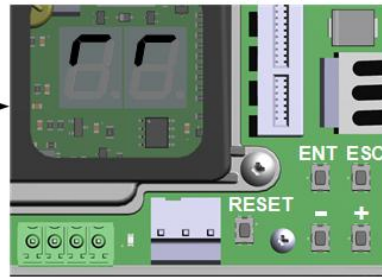

Press ENTER to enter the menu

2

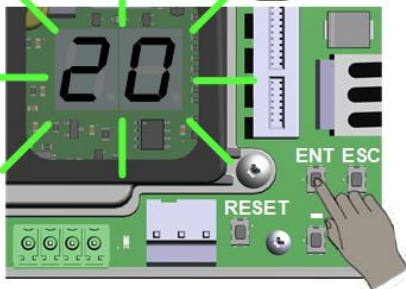

7

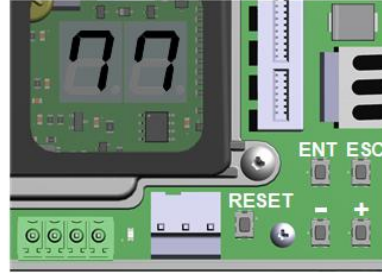

Edit Value

3

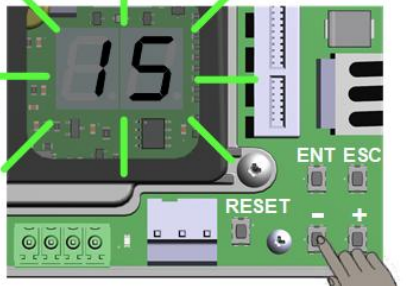

8

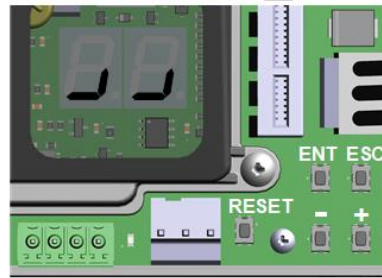

Press ENTER for confirmation

4

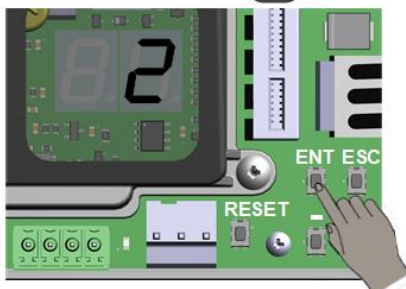

9

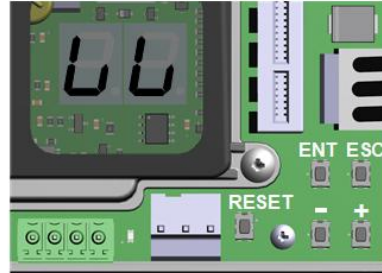

Press ESC to SAVE The changes

5

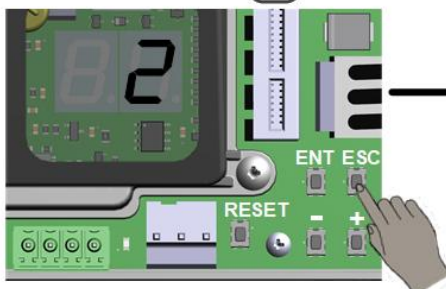

10

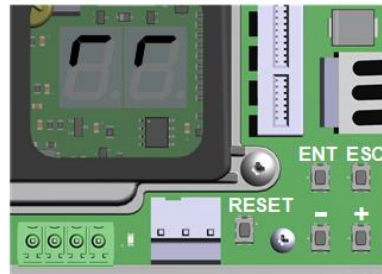

Displays turn clockwise when saving

5.2. Digidor

For detailed information on how to use the Digidor, please refer to the specific user manual.

PARAMETER ADJUSTMENT



In the "Parameter adjustment" menu you can find the complete list of all the operating parameters of the door. There are three types of regulation, type **A - B - C**:

Adjustment A

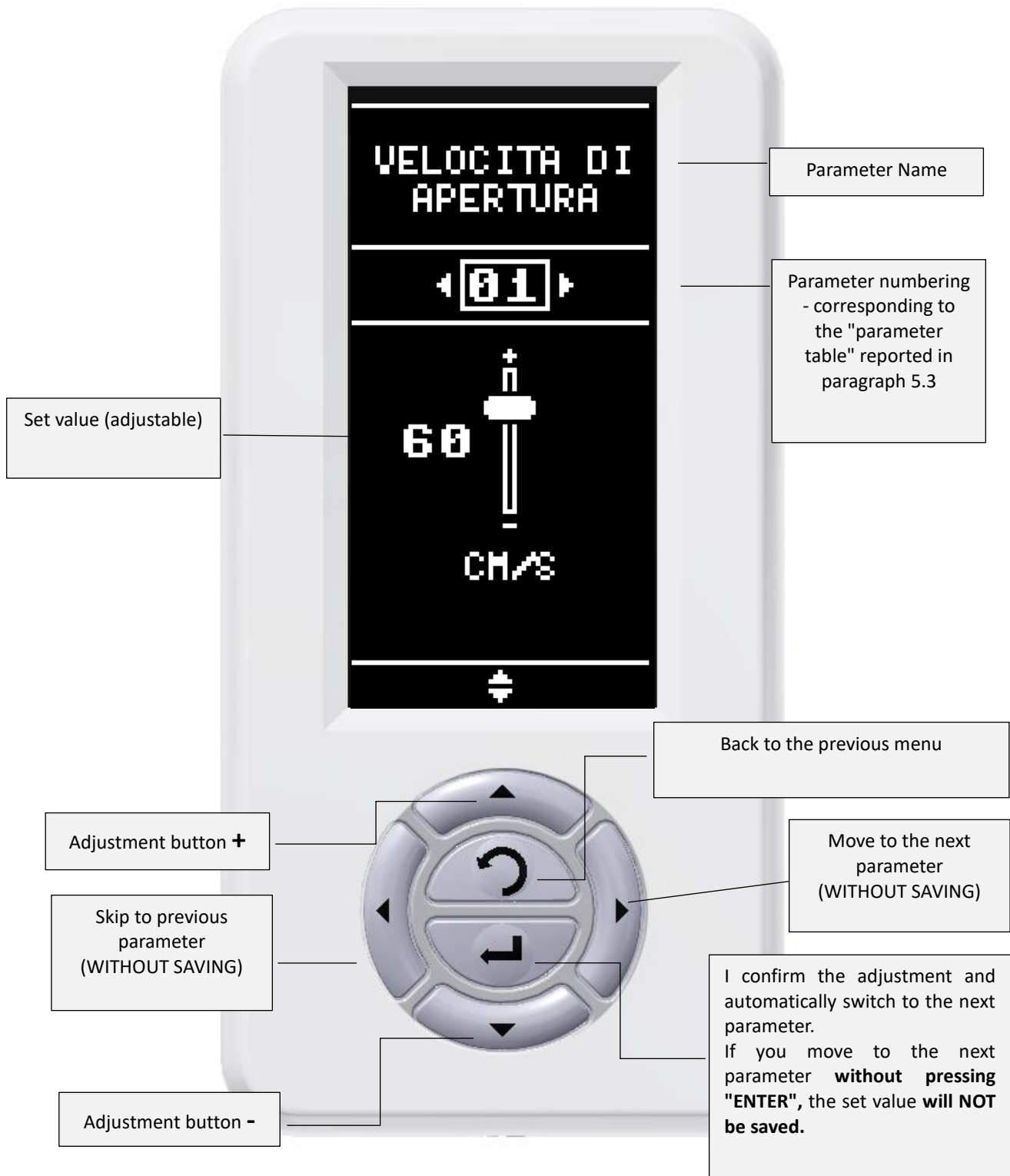

Adjustment B



Parameter Name

Parameter numbering - corresponding to the "parameter table" shown in the operator manual

Available features

GESTIONE BATTERIA	GESTIONE BATTERIA	GESTIONE BATTERIA
◀ 33 ▶	◀ 33 ▶	◀ 33 ▶
1	2	3
FUNZION. NORMALE	FUNZION. ANTIPANICO	SICUREZZA CON CONTROLLO CARICA
⬇	⬇	⬇

Back to the previous menu

Scroll through the available features

Skip to previous parameter (WITHOUT SAVING)

Move to the next parameter (WITHOUT SAVING)

Adjustment button -

I confirm the adjustment and automatically switch to the next parameter.
If you move to the next parameter **without pressing "ENTER"**, the set value **will NOT be saved.**

C Adjustment

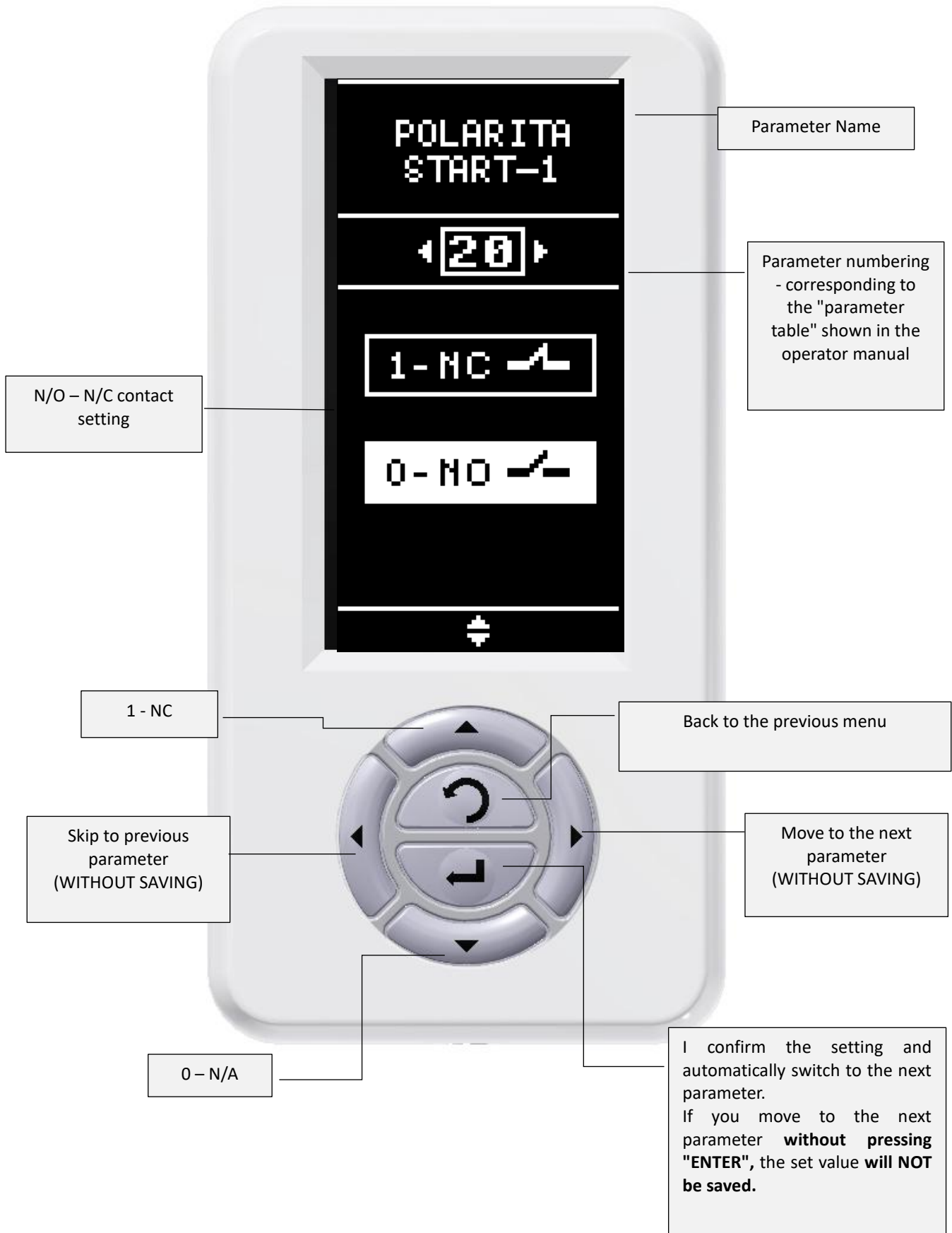

5.3. Parameters

You can change the value of the settings and operating parameters using one of the methods mentioned at the beginning of paragraph 5.

The following table shows the parameters and the relative code (ID). The factory default value is shown in the "Default" column.

⚠ DANGER: the setting of the parameters is essential for safety purposes; make sure you have the necessary skills to perform them correctly, otherwise functionality and/or safety devices may be compromised and the automatic movement of the leaves could cause serious damage to property or people with risk of fatal injury.

TABLE 1 – CONFIGURATION PARAMETERS

ID	Description	Adjustment	Default
01	Opening Speed	20 – 70 Opening speed in cm/sec. Adjustment step 5cm/sec.	60
02	Closing Speed	10 – 40 Closing speed in cm/sec. Adjustment step 5cm/sec.	20
03	Lay over time	0 – 64 Dwell time in the Open Doors state. Adjustment step 1 0 – 60 Adjustment in units of seconds 61 1 minute 62 2 minutes 63 3 minutes 64 4 minutes	0
04	Anti-crush Opening	1 – 9 Crush detection sensitivity during opening (1 Maximum sensitivity, 9 Minimum sensitivity)	9
05	Anti-crush Closing	1 – 9 Crush detection sensitivity during closing (1 Maximum sensitivity, 9 Minimum sensitivity)	5
06	Partial Percentage	30 – 90 Percentage of Partial Logic Opening with respect to the Total	50
07	Approach Speed	3-10 Speed in cm/sec in the final phase of the movement, Adjustment step 1cm/sec.	5
08	Accelerations	10 – 30 Acceleration ramp adjustment. Adjustment Step 1 (10 Minimum Acceleration, 30 Maximum Acceleration)	24
09	Decelerations	5 – 20 Deceleration ramp adjustment. Adjustment step 1 (5 Minimum deceleration, 20 Maximum deceleration).	16
10	Combination	4 – 40 Length of the approach phase in cm. 1cm adjustment step modification of both values (opening equal to 1/2 of closure)	20
11	Opening Limit	0 – 50 Percentage of opening limitation compared to the total stroke of the leaf detected during the LP operation. Adjustment steps 1%.	2
12	Holding force closed doors	0 – 9 Thrust force with the motor for keeping the doors closed. Adjustment step 1, 0 Disabled 1–9 Enabled (1 minimum force, 9 maximum strength)	0
13	Type of electric lock	0 Not used 1 Normal – Fail Secure 2 Invers – Fail Safe 3 Bistable 4 Normal – Fail Secure Double (2 in parallel) 5 Reverse – Fail Secure Safe (2 in parallel) 6 Electromagnetic Brake on Motor or Pulley – Fail Safe 24VDC 7 Bistable + Electromagnetic Brake 8 Mag Lock on Carriage – Fail Safe 24VDC 9 Bistable + MagLock	1
14	Door lock logics with electric block or motor	0 Lock Off 1 Active Exit Only Lock 2 Active Lock in Automatic 3 Active Exit Only and Automatic Lock If no electric lock is selected, the door lock is carried out with the motor	1

ID	Description	Adjustment	Default
15	IN7 Configuration (Auxiliary Input 1)	0 Emergency opening	1
		1 Master Interlock	
		2 Slave Interlock	
		3 Pharmacy opening	
		4 Start 2 Command	
		5 Semi-automatic	
		6 Stop movement	
		7 Single partial opening control	
		8 Set partial opening on all inputs	
		9 Semi-automatic with automatic closure	
		10 Set Output Only Logic	
		11 Set Closed Stop Logic	
		12 Closes even if safe close is active	
		13 Partial (single pulse) or total (double pulse within 0.5sec) opening control, partial dwell time parameter 39, total dwell time parameter 3)	
14 Start 1 Command			
15 not available			
16 not available			
17 Input not used			
16	IN8 Configuration (Auxiliary Input 2)	As Auxiliary Input 1	0
17	Auxiliary Output Configuration	0 Not used	1
		1 Interlock	
		2 Open door status	
		3 Door Closed Status	
		4 Breakdown	
		5 Ringtone	
		6 Start 2 activated	
		7 Start 1 Activated	
		8 Active Output-Only Logic	
		9 Electric block activated	
		10 Port locked (by selector switch or key contact)	
11 Batteries: ON signal port operating with batteries, flashing signal low batteries			
18	Multi Master Address	0 No Multi Master management, 1– 15 Unique address for Multi Master connections	0
19	Selection of weights	Wings weight value, the weight value corresponding to the Low-Medium-High levels depends on the type of actuator and motor used	0
		0 Machine learning	
		1 Low weight level	
		2 Medium Weight Level	
3 High Weight Level			
20	Input Polarity IN1 (Start 1)	0 ON	0
		1 NC	
21	Input Polarity IN2 (Start 2)	0 ON	0
		1 NC	
		2 FREQ (ER140 only)	
22	IN5 input polarity (SAFE Open 1)	0 ON	1
		1 NC	
23	IN6 input polarity (SAFE Open 2)	0 ON	1
		1 NC	
24	Input Polarity IN3 (SAFE Close 1)	0 ON	1
		1 NC	
25	Input Polarity IN4(SAFE Close 2)	0 ON	1
		1 NC	

ID	Description	Adjustment	Default
26	IN7 Input Polarity (Aux In1)	0 ON 1 NC	0
27	IN8 Input Polarity (Aux In2)	0 ON 1 NC	0
28	Key Input Polarity	0 ON 1 NC	1
29	Aux Out Output Polarity	0 ON 1 NC	0
30	Test Safe Close Output Polarity	0 ON 1 NC	1
31	Test Safe Open Output Polarity	0 ON 1 NC	1
32	Key	Selection of KEY input operating modes 0 Bistable 1 Monostable 2 Bistable – no movement on reactivation 3 Monostable – no movement on reactivation 4 Bistable opening command in "Locked" mode, an opening is commanded but the door remains locked at night. 5 Bistable, redundant contact, only for ER140.	0
33	Battery Management	Battery mode selection 0 Battery Not Used 1 Battery Present normal operation 2 Battery Present anti panic operation 3 Not used 4 Battery present, forced closure in case of main failures. 5 Battery Safety supervision is present. Not for ER140	0
34	Use of IR sensors	Activation of the use of IR sensors on connector 37-40. Not compliant with EN16005 0 IR sensors not used 1 Active IR single beam	0
35	Mode SAFE Open	Operation mode when SAFE Open safety sensors are activated when opening 0 Stop Motion until sensors are deactivated 1 Slow movement with 200mm limit from full aperture 2 Slow movement until fully open 3 Slow movement with 500mm limit from full aperture	0
36	Pharmacy opening	5 – 50 Percentage of opening in case of Pharmacy opening command. Adjustment step 1	10
37	Special Operation Management	0 None 1 Operation with elastic band	0
38	Reset speed	5 – 15 Speed in cm/sec during the Reset maneuver. Adjustment steps 1cm/sec.	10
39	Emergency Opening Dwell Time	0 – 60 Dwell time in seconds in the Open state following an Emergency command. Adjustment step 1 second	5
40	Opening direction selection	Selection of the direction of door opening. 0 Opening direction defined in procedure "LP" 1 Default opening direction 2 Opening Direction Inverted	0
41	Opening delay	Enable and set the delay between the command and the door opening, active regardless of whether or not the lock is unlocked. Adjustment step 0.1 seconds. 0 Inactive 1 – 99 Active	0







ID	Description	Adjustment	Default
42	SAFE Close → Start	Opening activation via SAFE Close sensor in the closed door state. 0 SAFE Close does not open when the door is closed 1 SAFE close activates opening with the door closed	0
43	Anti-crushing in low energy	1 – 9 (1 Maximum Sensitivity, 9 Minimum Sensitivity)	3
44	Closing movement before opening (water hammer)	Enable forced closure activation to facilitate unlocking. 0 Only in case of non-opening 1 Always	0
45	Full partial opening	Enable full opening of the leaves if partial logic is selected. 0 Disabled, always partial open 1 Enabled, if partial logic is selected, in case of simultaneous activation of both start signals, a total opening is commanded. In the next cycle, the opening will be partial again.	0
46	Pull & Go	Activation and selection of the sensitivity of the Pull&Go function 0 Function inactive 1 – 5 Active function (1 Maximum sensitivity – 5 Minimum sensitivity)	0
47	SAFE supervision	0 – F Supervision configuration of the SAFE sensors (see detail Table 4 – SAFE Test Configuration).	0
48	Delay for Last Exit	Enable and set delay to disable the START2 command input after the transition to night mode made by means of the KEY contact or Logic selector. 0 Off, Disable START2 Input immediately. 1 - 6 Active (1 Minimum – 6 Maximum, each step 10 seconds)	0
49	Logic Shift Roto K5	Logic selected on position 5 RotoK5 selector switch 0 Partial Automatic Logic 1 Manual logic OFF (logic with manual movement only no autonomous movement)	0
50	Opening delay in case of lock lock	Enable and set the delay between the command and the door opening, active only if the lock is unlocked. Adjustment step 0.1 seconds. 0 Inactive 1 – 99 Active	0
51	Manual logic functionality	Selection of operating modes in manual logic. 0 In manual logic, the door can be activated by the button on the selector or be moved manually, the reclosing is automatic. 1 In manual logic, the door can only be moved manually, any autonomous movement is inhibited.	0
52	Standard/office mode	Type of installation 0 Standard 1 Office 2 Do not use	0
53	Configuration IN1 (Start 1)	As parameter 15	14
54	IN2 Configuration (Start 2)	As parameter 15	4
55	IN3 Configuration (SAFE Close 1)	As parameter 15 with the addition of: 15 SAFE CLOSE	15
56	IN4 Configuration (SAFE Close 2)	As parameter 15 with the addition of: 15 SAFE CLOSE	15
57	IN5 Configuration (SAFE Open 1)	As parameter 15 with the addition of: 16 SAFE OPEN	16
58	IN6 Configuration (SAFE Open 2)	As parameter 15 with the addition of: 16 SAFE OPEN	16

ID	Description	Adjustment	Default
59	Type of Automatism	Actuator type selection (Cx code) 0 PW100. 1 PW140. 2 PL55. 3 PW250. 4 HERMETIC. 5 PWT80 6 ERT80 7 ER140 8 FOLDING	--
60	Operator options	Operator management logic option 0 None 1 Double Master 2 Double Slave 3 Dual Slave Motor	0
61	Firm Door Lock Options	Door Hold Mode Locked with Electromagnetic Brake or Maglock 0 Lock only if activated Electric lock 1 Lock only in closed door conditions 2 Always Lock (only with Electro-Mechanical Brake)	0

5.4. Operating Controls

In addition to the parameter modification described above, it is possible to send some operational commands:

TABLE 2 - OPERATING COMMANDS

Indication	Description	Notes
	Default setting parameters and information length and weight before	See paragraph 0
	Activation of the travel and weight acquisition wizard	See paragraph on Start-up.
	System Information	See paragraph 5.4.2
	Password	
	Added ICON selector TAG	See paragraph (instructions for ICON)
	Erase TAG ICON selector switch	
	Display Display Selection	See paragraph 5.4.3

5.4.1. Sd Procedure (SET TO DEFAULT)

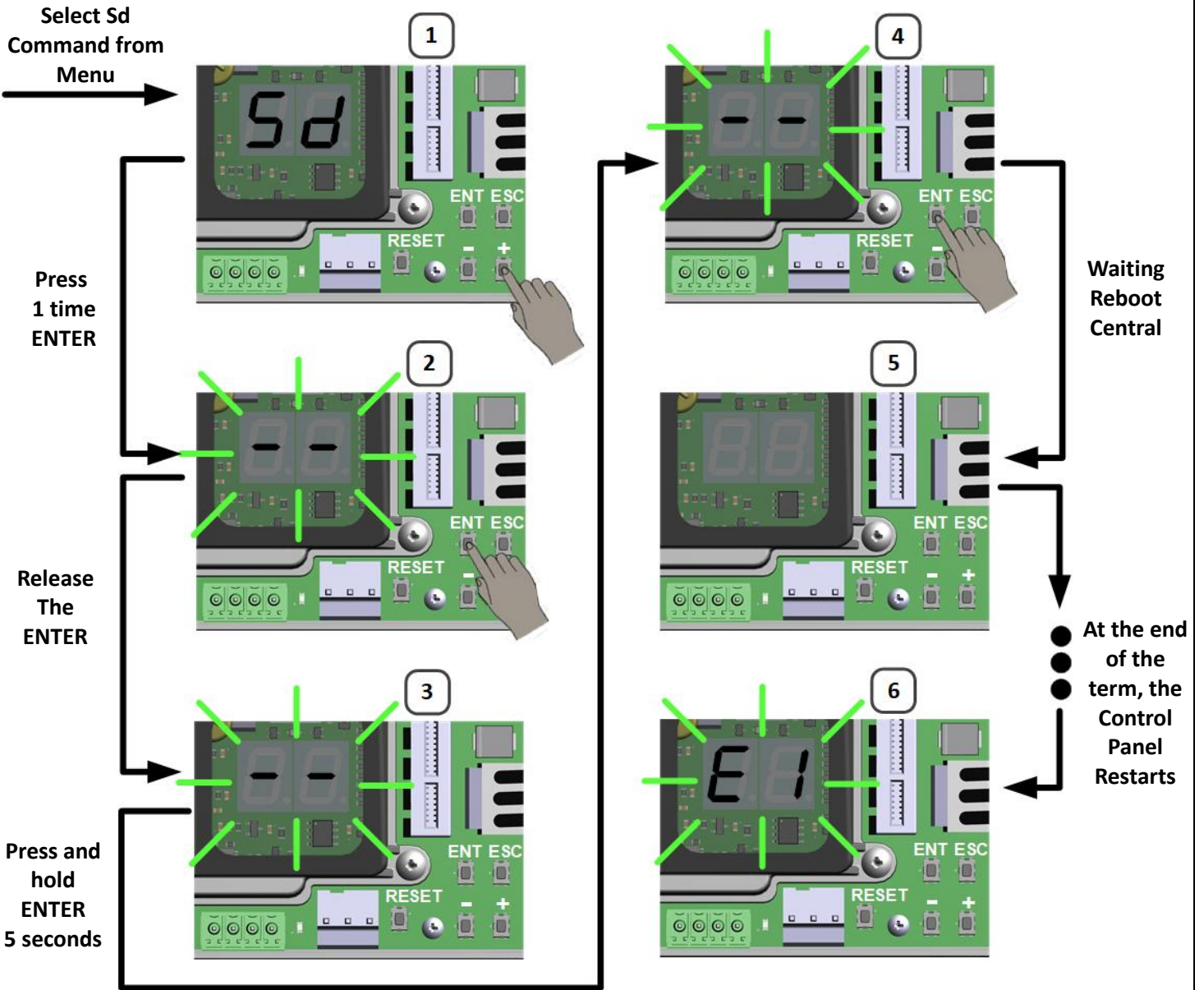

5.4.2. System Information In

The **In (Information)** menu provides a range of information that can be selected through an index as shown in the following table:

TABLE 3 – INFORMATION INDEX

Table of Contents	Description
0	Firmware version of the User Microcontroller (LS) e.g. 1.06
1	Safety Microcontroller (TE) firmware version e.g. 1.02
2	Actuator Code Cx
3	Total weight of the leaves detected during the LP procedure or set: P0 (Low level); P1 (Medium Level); P2 (High Level)
4	Total number of operations performed by the control panel
5	Configuration of supervision on installed sensors – see table below

Coding Safety Sensor Supervision Test according to EN16005.

If ON, it means that the sensor is tested before a cycle in which its operation performs a safety function. In the event of an error, the cycle is not carried out or is carried out at reduced speed.

If OFF the test is not run.

TABLE 4 – SAFE TEST CONFIGURATION

Reporting	SAFE Open 2	SAFE Open 1	SAFE Close 2	SAFE Close 1
S0	OFF	OFF	OFF	OFF
S1	OFF	OFF	OFF	ACTIVE
S2	OFF	OFF	ACTIVE	OFF
S3	OFF	OFF	ACTIVE	ACTIVE
S4	OFF	ACTIVE	OFF	OFF
S5	OFF	ACTIVE	OFF	ACTIVE
S6	OFF	ACTIVE	ACTIVE	OFF
S7	OFF	ACTIVE	ACTIVE	ACTIVE
S8	ACTIVE	OFF	OFF	OFF
S9	ACTIVE	OFF	OFF	ACTIVE
SA	ACTIVE	OFF	ACTIVE	OFF
Sb	ACTIVE	OFF	ACTIVE	ACTIVE
SC	ACTIVE	ACTIVE	OFF	OFF
SD	ACTIVE	ACTIVE	OFF	ACTIVE
IF	ACTIVE	ACTIVE	ACTIVE	OFF
SF	ACTIVE	ACTIVE	ACTIVE	ACTIVE

- Select Parameters in the In Menu (Information):

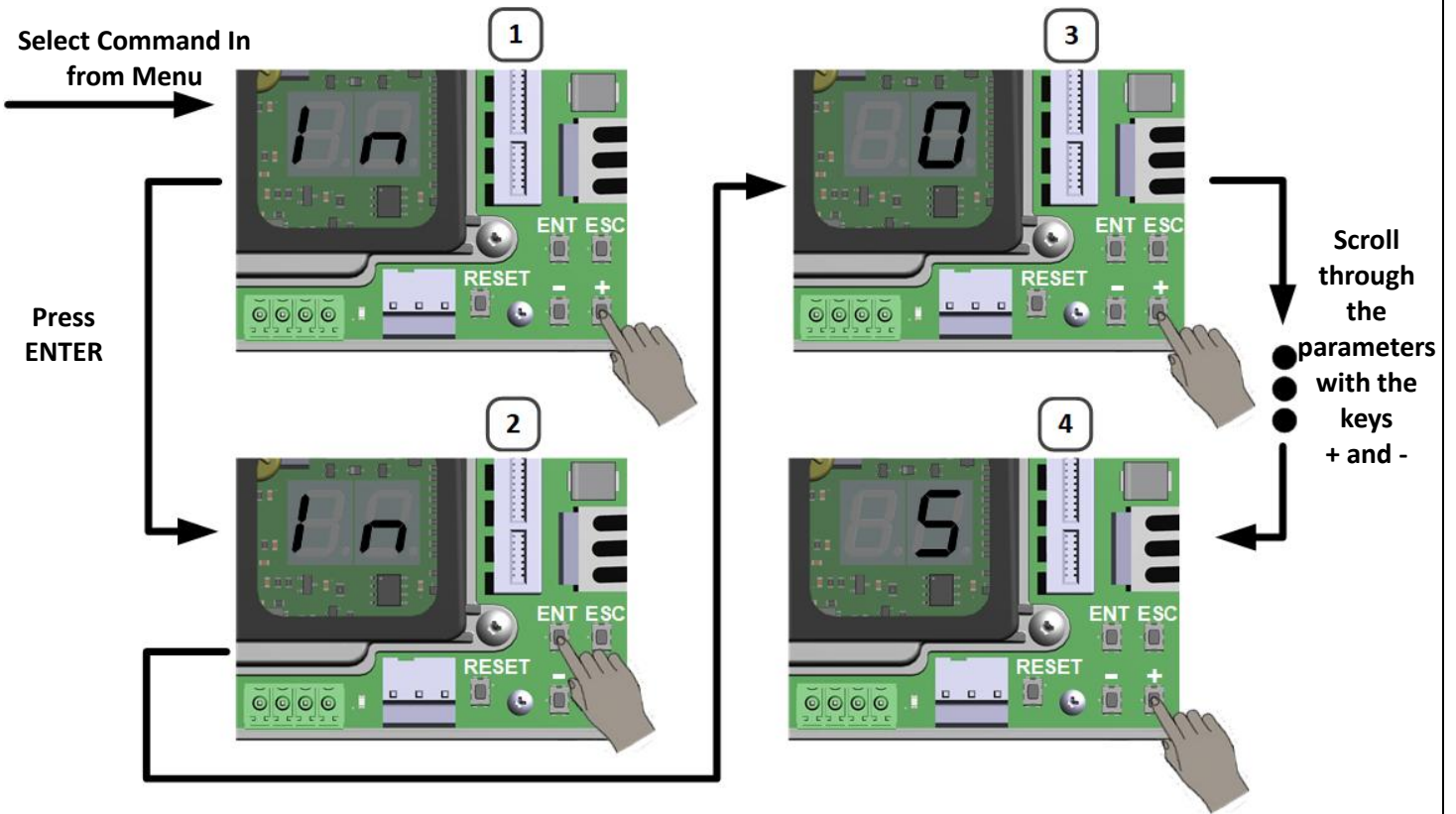

- Parameter 0 display example (user controller firmware version 1.03)

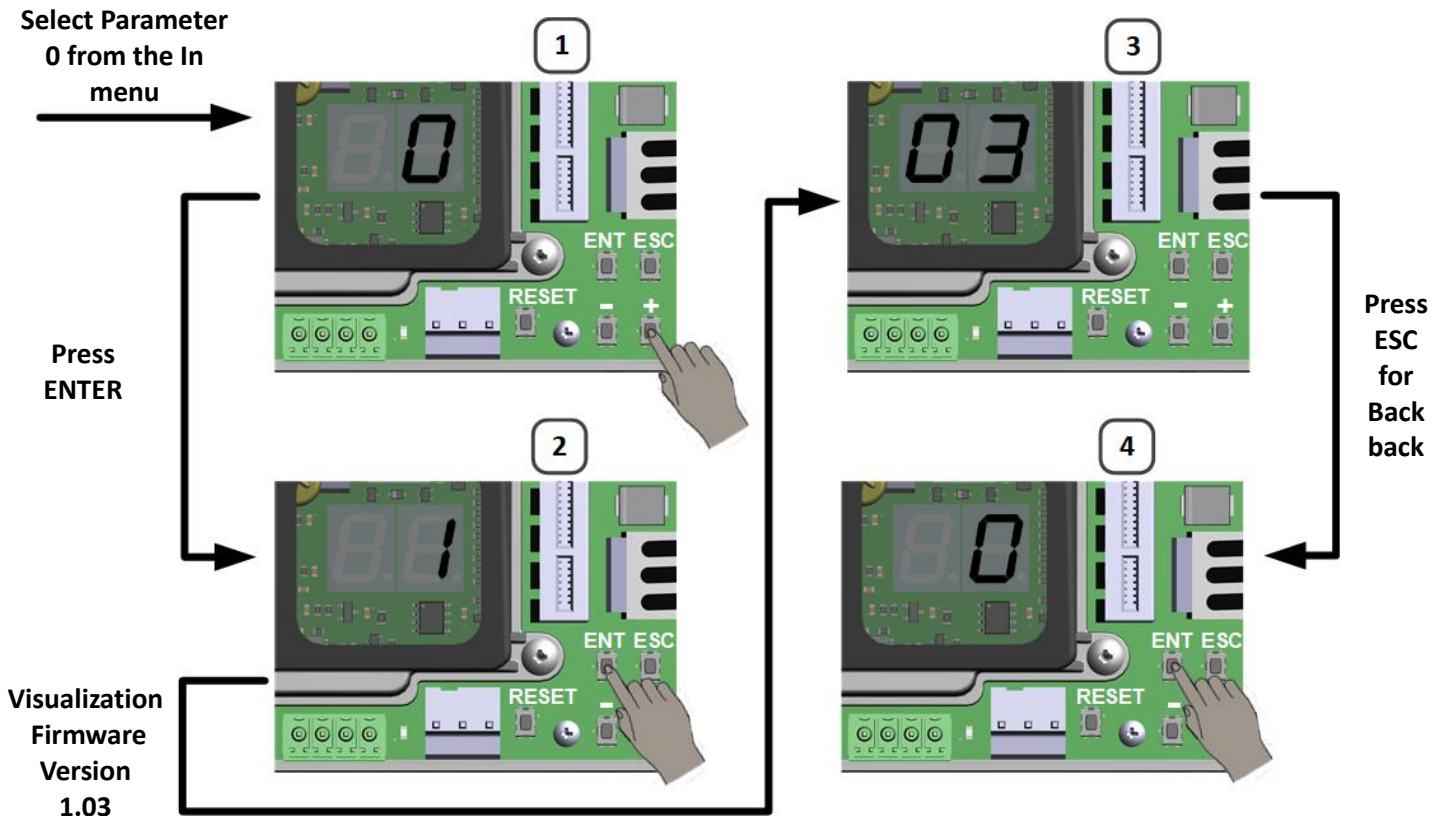

Press ESC to return to the previous menu for selecting the Parameters, in case of inactivity the system ends the display after 20 seconds.

The length of the displayed values depends on the length of the parameter to be displayed.

5.4.3. Display Display Selection dS

Using the Display display selection command you can choose between two different views:



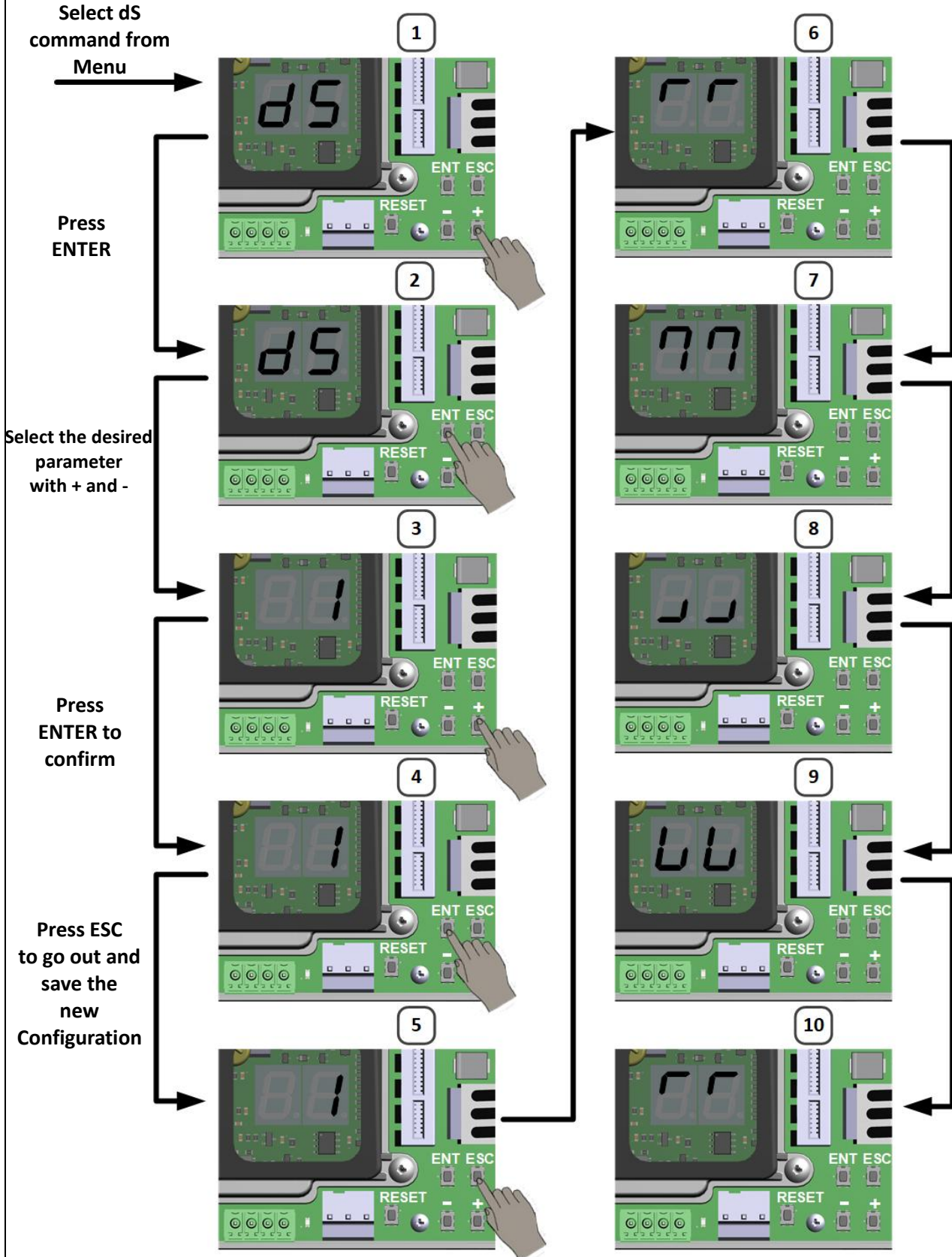

- normal operating conditions (0);
- Sensor Status (1);



5.4.3.1 Normal Operating Conditions

During regular operation, the display shows the following indications (Parameter dS = 0):

TABLE 5 – OPERATIONAL VISUALIZATIONS

Reporting	Description
	Door in firm position open
	Door being opened
	Door in closed position
	Door being closed
	Door in stop state following the detection of an anti-crushing device or intervention of the safety sensors when opening or KEY contact deactivated

5.4.3.2 Sensor Status

If the sensor status display is activated (Parameter dS = 1):

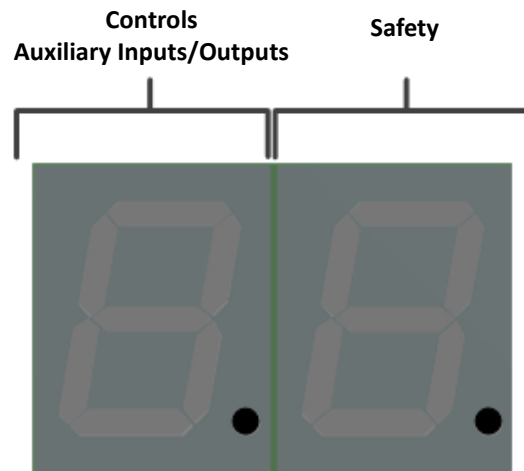

The image above shows the resting condition, no active signal. The two LEDs at the bottom right indicate that the display has been activated

- **Safety Sensors Status Display**

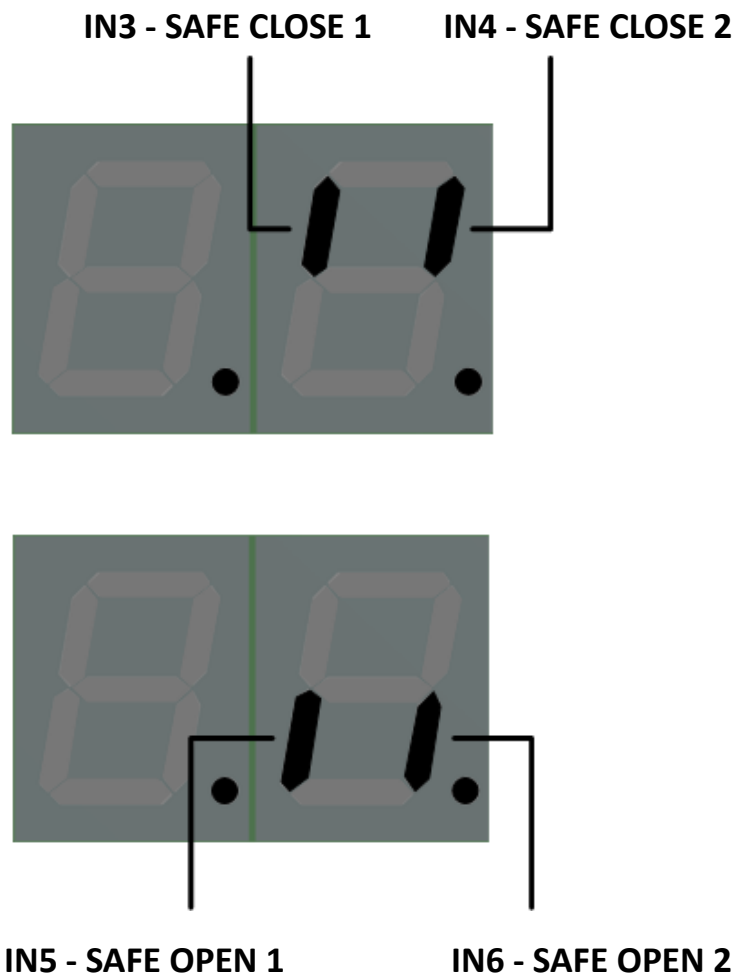

Activation of the display segment indicates that the sensor is engaged, regardless of the NO/NC polarity configuration of the input corresponding to the sensor on the board.

Photocell Status Display (only if used)

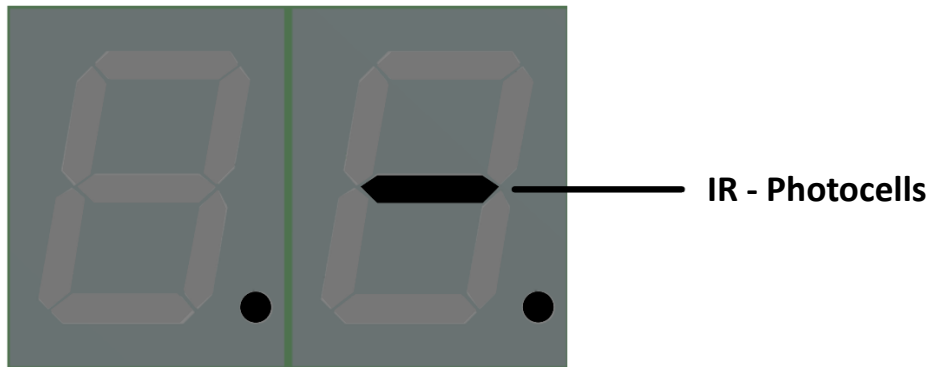

Command and Auxiliary Input/Output Status Display

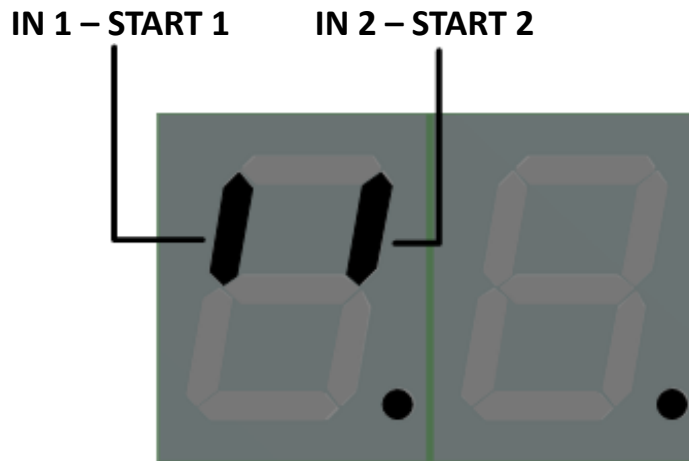





AUX OUT

Activation of the display segment indicates that the corresponding input/output is active, regardless of the NO/NC polarity configuration on the board.

6. COMMISSIONING

	WARNING RISK OF ELECTROCUTION
	CAUTION RISK OF CRUSHING
	CAUTION RISK OF DRAGGING

Individual devices for all operating phases:



6.1. GETTING STARTED

- Disconnect the 230Vac mains power supply and the emergency batteries (OPTIONAL):

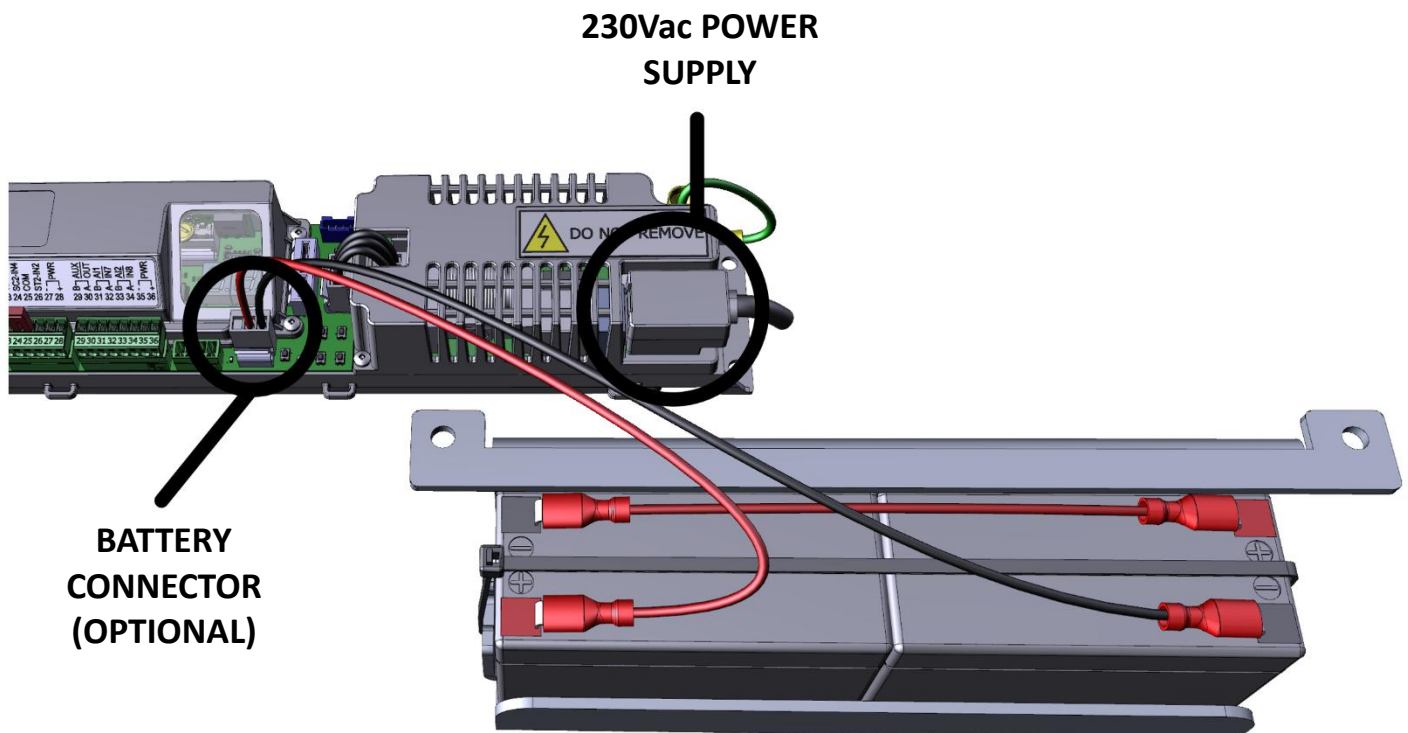

- Check that the leaves are smooth and frictionless by moving them manually;

6.2. Commissioning Sequence

The commissioning procedure allows the control center to acquire data essential for operation, such as the size of the sliding compartment, the weight of the leaves and the direction of opening.

The commissioning of the POWERCORE operator involves the following sequence of operations:

- 1- Mains power connection (230Vac);
- 2- Commissioning procedure (LP) via the User Interface, or Set Up procedure via the Digidor selector;
- 3- Parameter adjustment if necessary;
- 4- Check that all screws, anti-derailment of bogies, the box and all elements stressed by stress and vibrations during operation are correctly tightened;
- 5- Final verification of the correct functioning of all the installed safety devices with the use of the specific instrumentation provided for by the EN16005;

⚠ DANGER: All activities from 1. to 5. above are essential for safety purposes; make sure you have the necessary skills to perform them correctly, do not omit any steps or checks. Failure to do so may compromise an important safety function and the automatic movement of the leaves may cause serious damage to property or persons with a risk of fatal injury.

⚠ WARNING: if no optional device is installed for the night closing control, make sure that the KEY input is short-circuited, connector J22 terminals 7 and 8 otherwise, it will not be possible to start the operator.



⚠ WARNING: check that the safety sensors installed comply with the safety requirements indicated by the EN16005 standard in relation to the risk analysis conducted for the system.

⚠ WARNING: If the side safety sensors have been installed, check that you have removed the jumpers on terminals 10/11 and 14/15.

6.2.1. Power supply connection

Power the control panel via the 230Vac mains power supply:

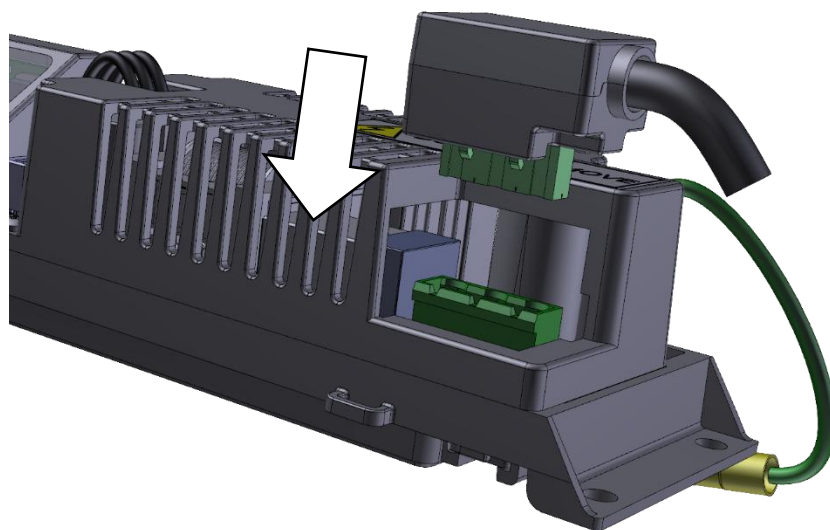

6.2.2. Power On Display

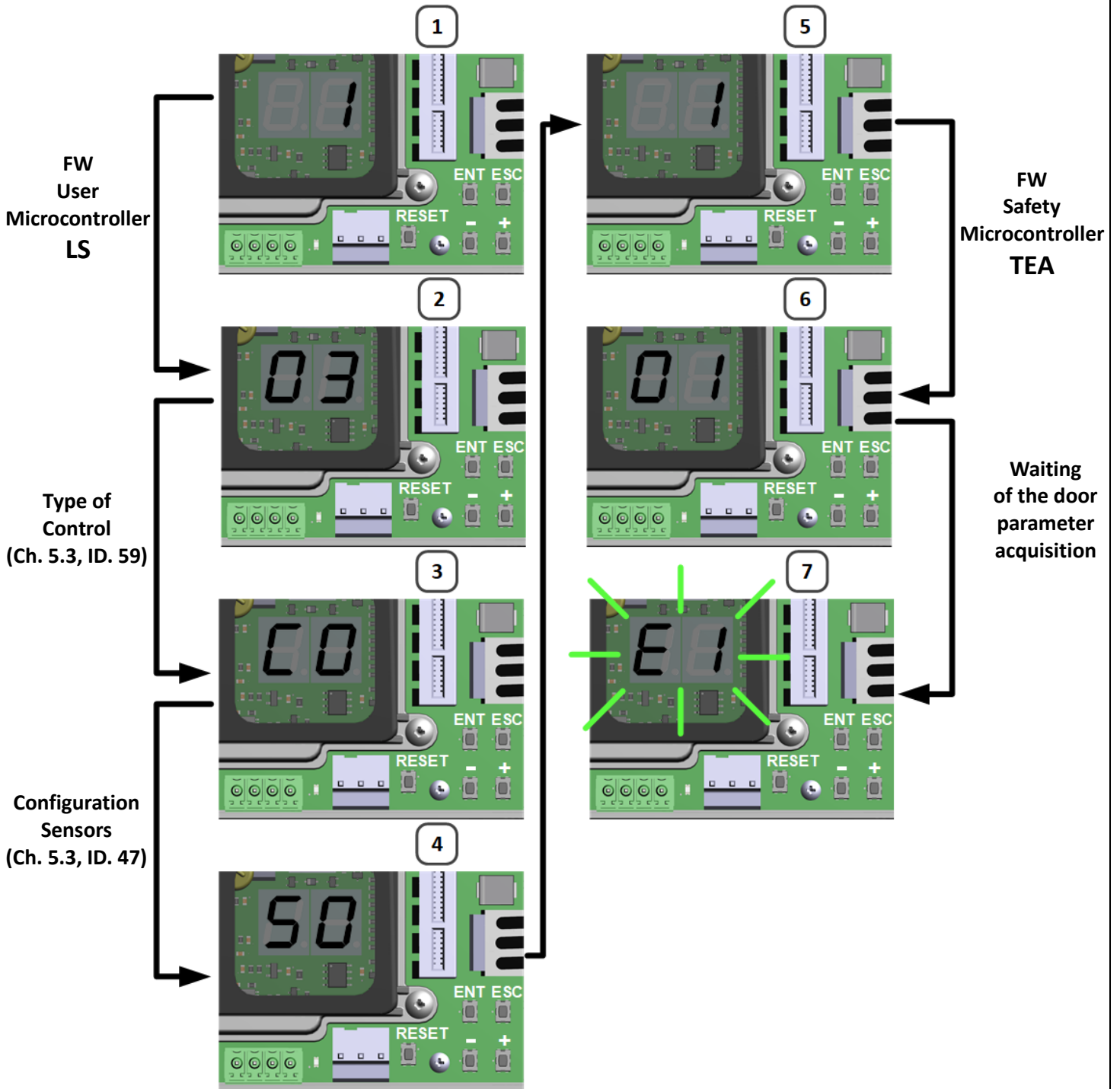

CAUTION: before continuing with the start-up procedure, check that the control panel is in **Waiting for Door Parameter Acquisition (E1 Flashing)** as indicated above, if not, proceed first with the Procedure Sd Chapter 5.4.1 and only then proceed to the next step.

6.2.3. Quick LP Procedure via User Interface

The Display should show E1 flashing

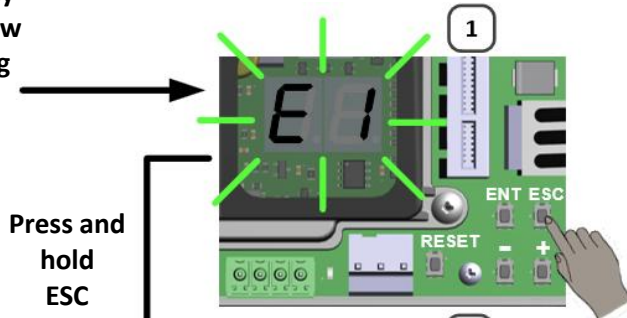

Press and hold ESC for 5 seconds

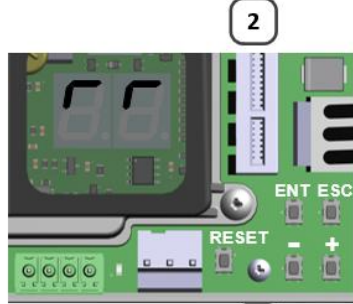

When Display starts to rotate clockwise it indicates LP Procedure Start

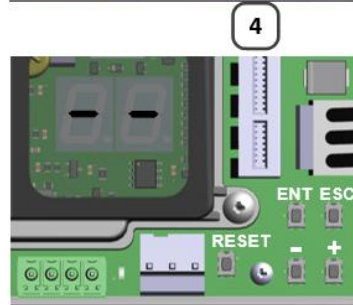
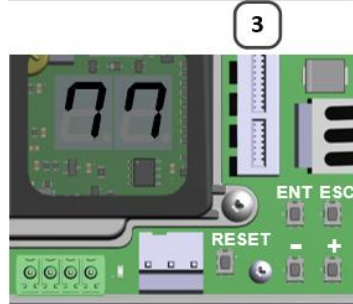

Configuration Sensors (Ch. 5.3, ID. 47)

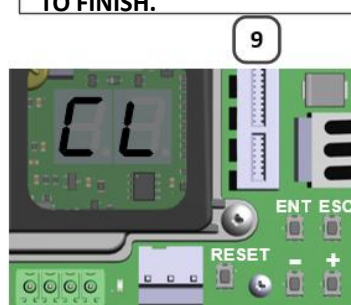
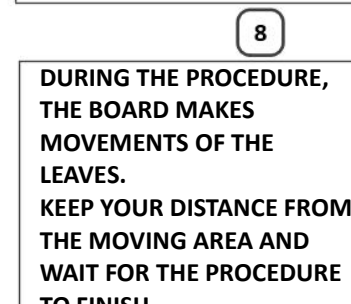
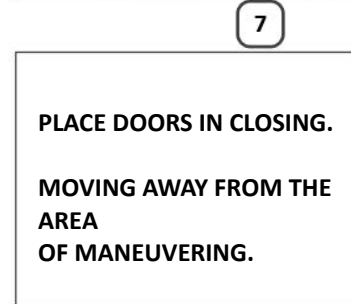
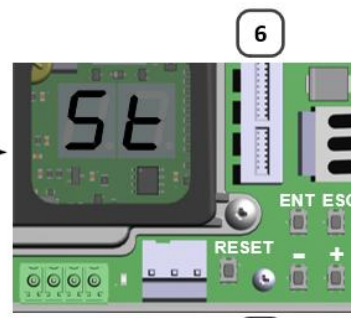
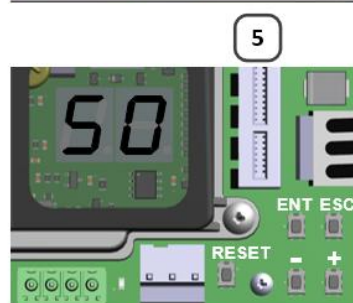

CAUTION

CAUTION

At the end the doors close and the status is CL



If at the end of the procedure the doors remain open with the indication of "OP" on the display and with the "Safety status LED on" (Chap. 3.2.2 point H) means that at least one safety sensor (SAFE Close 1 or SAFE Close 2) is engaged and therefore the control panel cannot proceed with the locking.

6.2.4. LP Procedure via User Interface

Select LP Command from Menu

Press 1 time ENTER

Release The ENTER

Press and hold ENTER for 5 seconds

When Display starts to rotate clockwise it indicates LP Procedure Start

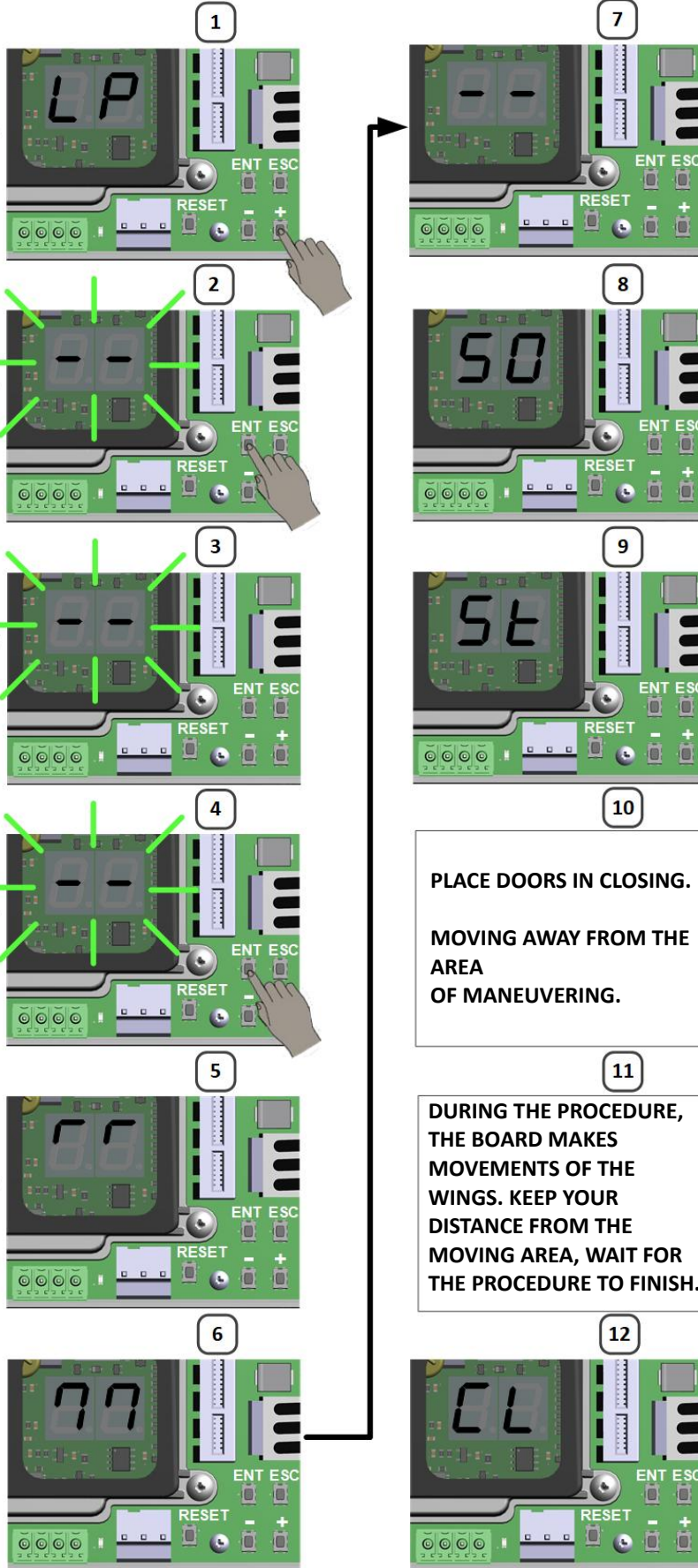

Configuration Sensors (Ch. 5.3, ID. 47)

 CAUTION

 CAUTION

At the end the doors close and the status is CL



If at the end of the procedure the doors remain open with the indication of "OP" on the display and with the "Safety status LED on" (Chap. 3.2.2 point H) means that at least one safety sensor (SAFE Close 1 or SAFE Close 2) is engaged and therefore the control panel cannot proceed with the locking.

6.2.5. Set Up procedure using the Digidor selector

For details on how to access the Set Up procedure, see the product-specific manual.

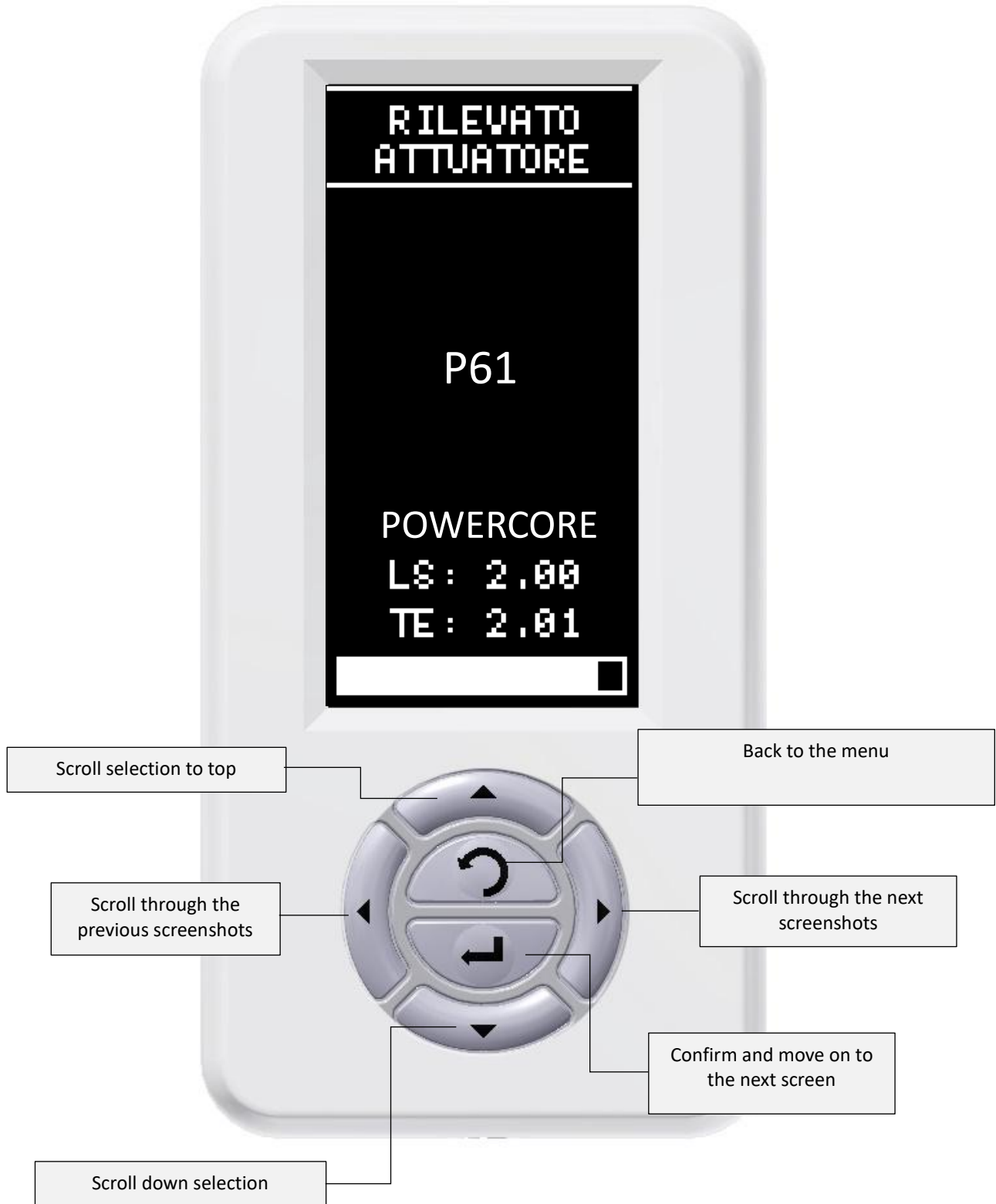

Note: The factory selected settings are in accordance with the EN16005

Commissioning consists of a series of guided operations specified below:

1st Operator detection, wait



2° Set the safety when closing the internal sensor S2. Confirm with ENTER



3° Set the test for the safety when closing the internal sensor S2. Confirm with ENTER



WARNING!!! NOT SELECTING THE TEST MAKES THE INPUT NOT COMPLIANT WITH THE EN16005 STANDARD .

4° Set the safety when closing the external sensor S1. Confirm with ENTER



5° Set the test for safety when closing the external sensor S1. Confirm with ENTER



WARNING!!! NOT SELECTING THE TEST MAKES THE INPUT NOT COMPLIANT WITH THE EN16005 STANDARD .

6° Set the opening safety of the right sensor S3 – if present. Confirm with ENTER



7° Set the test for the safety when opening the right sensor S3. Confirm with ENTER



WARNING!!! NOT SELECTING THE TEST MAKES THE INPUT NOT COMPLIANT WITH THE EN16005 STANDARD .

8° Set the opening safety of the left sensor S4 - if present Confirm with ENTER



9° Set the test for the safety when opening the left sensor S4. Confirm with ENTER



WARNING!!! NOT SELECTING THE TEST MAKES THE INPUT NOT COMPLIANT WITH THE EN16005 STANDARD .

10° Set safety contact test polarity when closing : IXIO/VIO/SSR3ER = NC Confirm with ENTER



11° Set safety contact test polarity at the opening: IXIO/VIO = NC Confirm with ENTER



12° Diagnostic screen: if there are no ERROR signals, press ENTER to continue, otherwise recheck the settings made previously (NO/NC – wiring)



13° If present Set type of electric lock
Confirm with ENTER

14° If present, set the battery back up (OPTIONAL).
Confirm with ENTER

15th Feature not available
Confirm NOT PRESENT with ENTER



16° Press ENTER to start L.P. The selector will communicate the procedures it is performing through a series of screens. Wait for the learning procedures to complete. During these phases, do not allow people to pass through the door as ALL safety sensors are NOT working.

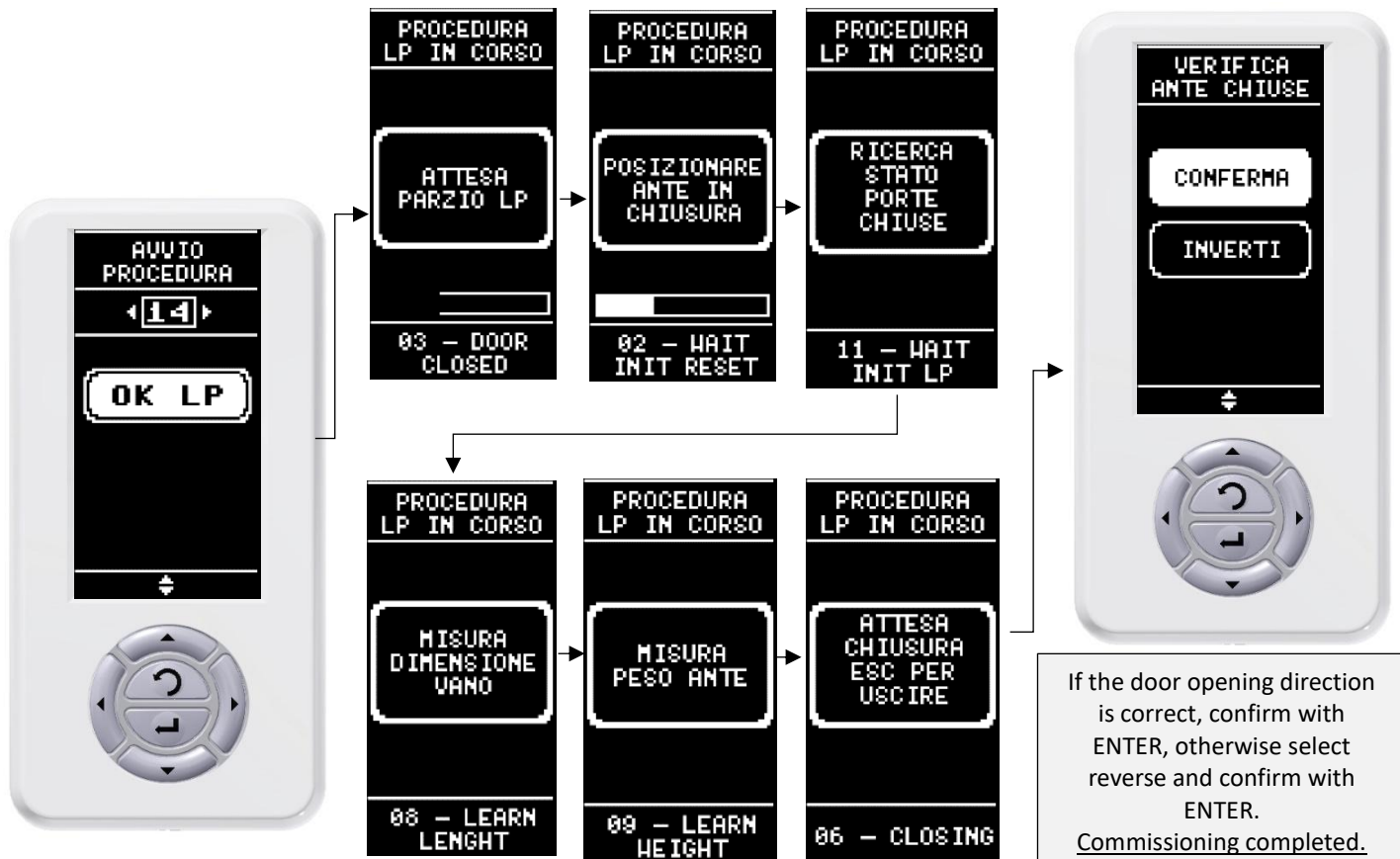

If the door opening direction is correct, confirm with ENTER, otherwise select reverse and confirm with ENTER.
Commissioning completed.

6.2.6. Parameter Adjustment

If you need to change configuration parameters, please refer to Chapter 5.3.

6.2.7. Final Verification

After completing commissioning, the operator is ready to operate in input/output logic. Check the following:

- The correct functionality of the S1/S2/S3/S4 sensors: follow the instructions in the EN16005 standard
- If the Battery KIT (optional) is installed, disconnect the mains power supply via the switch located upstream of the system and check the correct functionality of the operator, in accordance with what was selected with parameter 33;
- Reconnect the mains power supply via the switch located upstream of the system and check that the operator is restored to operation.
- Check the functionality of any auxiliary controls

7. DIAGNOSTIC

It is possible to view the diagnostics via the Digidor selector switch – see dedicated manual – or via the display of the electronic board.





7.1. Irregular Operation, Causes / Solutions

Description	Display Signaling	Cause/solution
The door remains open		<p>The Digidor/Icon selector is in the open stop position:</p> <ul style="list-style-type: none"> Change logic; <p>An open command or a safety is active, example: START1 - START2 - SAFE Close 1- SAFE Close 2 - Auxiliary Input configured as an emergency opening:</p> <ul style="list-style-type: none"> Check the status of the various inputs using diagnostics on the Digidor Selector or display, (see Paragraph 5.4.3.2);
No commissioning procedure begins		<p>Open KEY Contact:</p> <ul style="list-style-type: none"> Check the key contact using diagnostics on the Digidor Selector or display, (see Paragraph 5.4.3.2);
The door reverses during the closing phase		<p>During the closing movement of the door, the open control or the closing safety (SAFE Close) are activated;</p> <ul style="list-style-type: none"> Check which input is activated by diagnostics on the Digidor Selector or display, (see Paragraph 5.4.3.2); then calibrate the sensor; <p>Friction activates the reversal of movement:</p> <ul style="list-style-type: none"> Eliminate frictions;
The door stops during the opening phase and then closes again		<p>During the opening movement, the opening safety devices are activated:</p> <ul style="list-style-type: none"> Check which input is activated by diagnostics on the Digidor Selector or display, (see Paragraph 5.4.3.2); then calibrate the sensor <p>A friction activates the stop and the subsequent reversal of the movement:</p> <ul style="list-style-type: none"> Eliminate frictions;

7.2. Errors on the inputs of the SAFE Close 1 and 2, SAFE Open 1 and 2 safety devices:

Before each opening/closing, the control unit checks the active safety devices (sensors) using the appropriate test circuit and in the event of a fault does not perform the planned cycle. In this case, an error in code Fx is indicated on the display (ref. table below) which refers precisely to a pending test (waiting to be completed) of one of the installed safety devices:



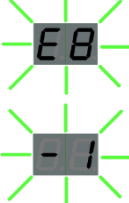
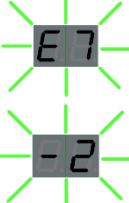



TABLE 6 - SENSOR ERRORS



Reporting	Description
	Supervision test on SAFE Close 1 failed
	Supervision test on SAFE Close 2 failed
	Supervision test on SAFE Open 1 failed
	Supervision test on SAFE Open 2 failed

The signal code indicates that the test on the relative safety sensor cannot be completed: this condition can be generated by a person/object in the sensor's range of action, by a sensor fault or by a wiring error of the sensor itself. Search for the problem by first checking that the sensor's field of action is free of people and/or objects and that the wiring is correct and intact.

7.3. Abnormal states at the time of ignition

The error messages in the table below indicate a fault that was present when the system was put into operation:

Reporting	Description	Solution
	Waiting for Port Parameter Acquisition	Carrying out commissioning procedure ("LP"), Chapter 6
	Type of Actuator not defined	Set Actuator Type via Parameter 59
	Motor-Encoder connection error	Check Motor/Encoder wiring. If the problem persists, replace the Motor
	Internal communication error between LS and TE	Automatic reset, if it persists, replace the electronic board It may occur temporarily after a firmware update is complete.
		
	OTE LS Test Error	Automatic reset, if it persists, replace the electronic board
	Encoder diagnostic error	Check Motor/Encoder wiring. If the problem persists, replace the Motor
	Power Supply Overload	Automatic reset, if it persists, replace the electronic board

	<p>Motor Short Circuit Detection</p>	<p>Check the correct setting of the type of actuator (parameter 59). Check Motor Wiring Turn off the board, disconnect the motor, and turn on again: - If the problem persists, replace the Electronics board. - If the problem no longer appears, replace the Motor.</p>
	<p>Automaton diagnostic error</p>	<p>Automatic Reset, Check Updated Firmware for LS.</p>
	<p>Wing Motion Timeout Error</p>	<p>Automatic Recovery, Check Updated Firmware Availability for TE.</p>