



# Digidor

## CONTENTS

CONTENTS .....	2
GENERAL INFO - INSTALLATION WIRING AND .....	3
NAVIGATION MODE MENU .....	5
FIRST SET UP .....	6
SCREEN .....	7
SELECTION MENU': LOGIC – SETTINGS - DIAGNOSTIC .....	8
SETTINGS .....	10
DIAGNOSTIC .....	12
CHECK-UP .....	13
SENSORS' STATUS – I/O .....	14
SYSTEM DIGNOSTIC.....	18
POWER SUPPLY DIAGNOSTIC.....	19
INFO .....	20
RESET .....	21
LOG .....	22
PARAMETERS SETTING.....	24
PASSWORD.....	27
MODIFY PASSWORD .....	28
PASSWORD TO LOCK THE KEYBOARD .....	30
DATE AND TIMINGS .....	31
CALENDAR SETTING .....	32
REDUCED LOGICS .....	34
START-UP.....	35
MAINTENANCE .....	39
FIRMWARE UPDATE .....	40
SET A DEFAULT .....	44
LANGUAGE SELECTION.....	45
TAG .....	46
SIGNAL TABLE.....	53

## GENERAL INFO - INSTALLATION WIRING AND





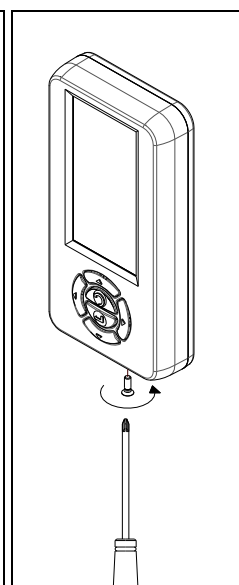
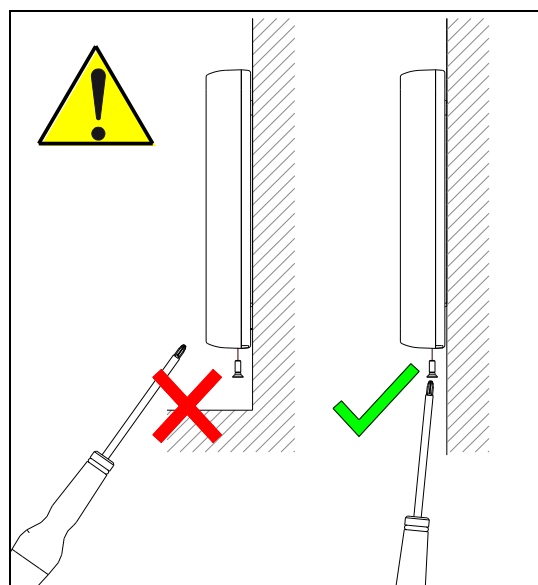
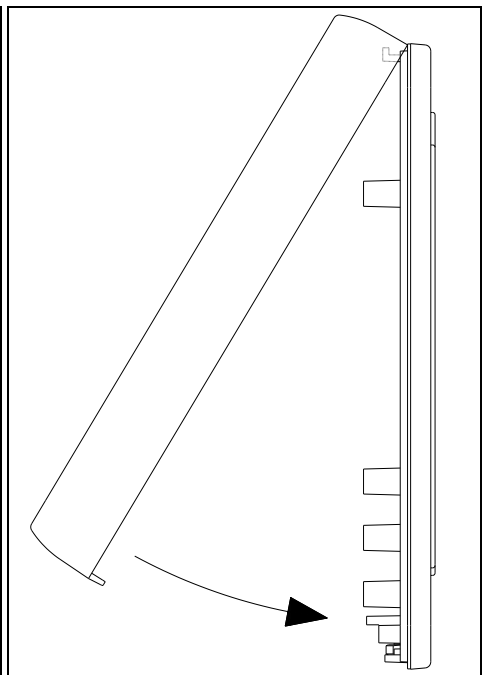
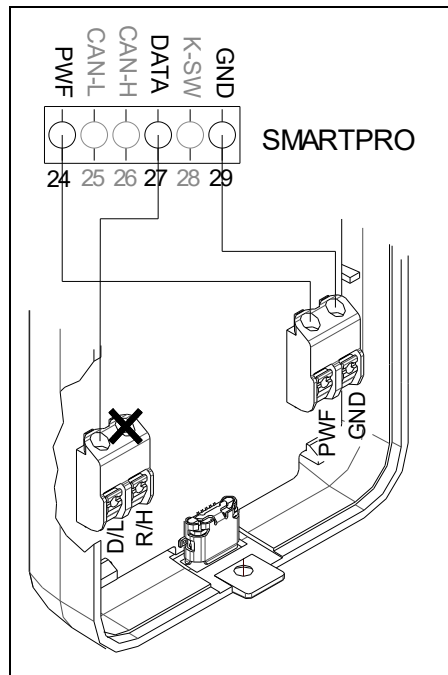
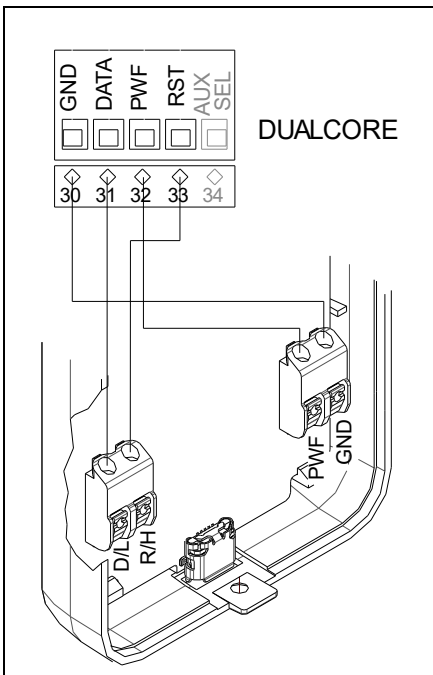
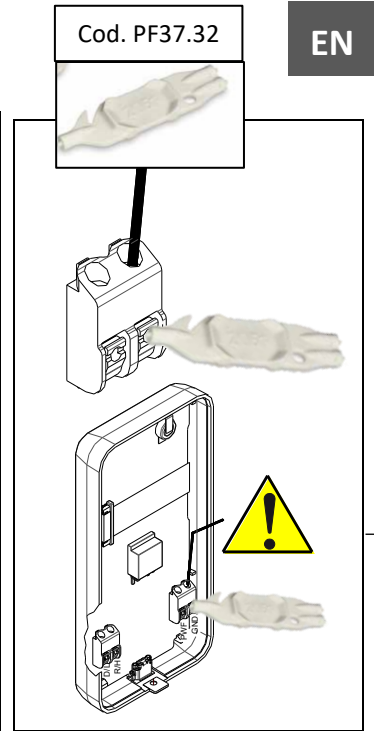
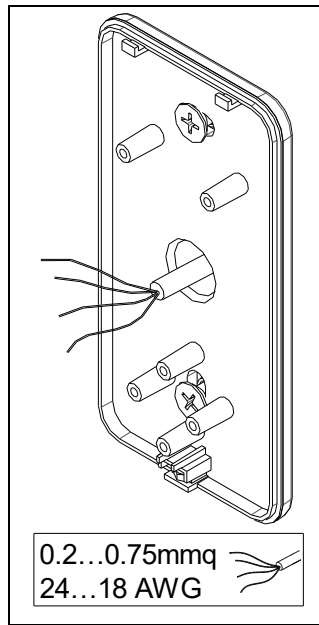
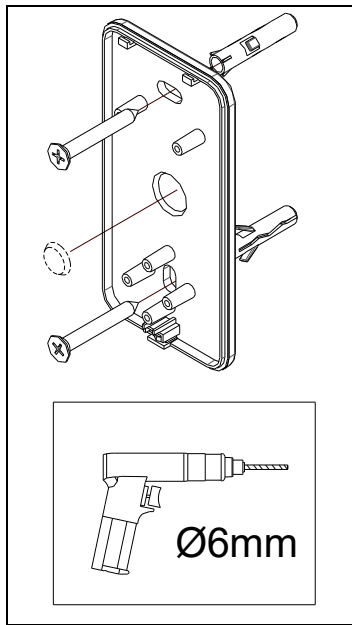
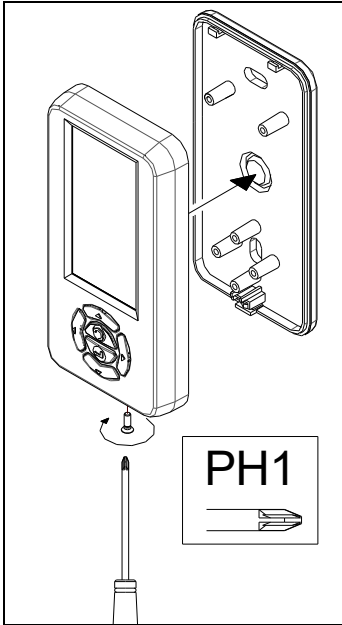



“DIGIDOR” programmer has been designed to work with all models of SESAMO operators, designed to be used from the end user to set the different logic of operation of the automatic door, either from the installer for the setting and commissioning, maintenance and securing the automatic door. DIGIDOR must be installed on the internal side of the building.



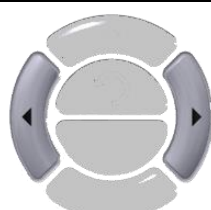

Use suitable tools and do not press too much to avoid damages- EN

## NAVIGATION MODE MENU

ICON	KEY	FUNCTION
	<b>ENTER</b>	Confirmation
	<b>ESC</b>	Exit from the menu / cancel
	<b>UP</b>	Scroll up
	<b>DOWN</b>	Scroll down
	<b>RIGHT</b>	Scroll right
	<b>LEFT</b>	Scroll left
	<b>OPENING COMMAND</b>	Pressing at the same time Right and Left Key will send a command to the door to open
	<b>SELECTION AREA</b>	Indicates logic/function/setting



FIRST SET UP



Push buttons: NAVIGATION MODE MENU



SCREEN

Icon service: Key selection: NAVIGATION MODE MENU

Icon connection: Key selection: NAVIGATION MODE MENU

Timing: DATE AND TIMINGS



Logic selected and active:  
SELECTION MENU': LOGIC -  
SETTINGS -  
DIAGNOSTIC **SELECTION**



Icon peripheral connection:  
Key selection:  
NAVIGATION MODE

By pressing any key to enter:  
SELECTION MENU': LOGIC -  
SETTINGS - DIAGNOSTIC



Key selection: NAVIGATION MODE MENU

SELECTION MENU': LOGIC – SETTINGS - DIAGNOSTIC

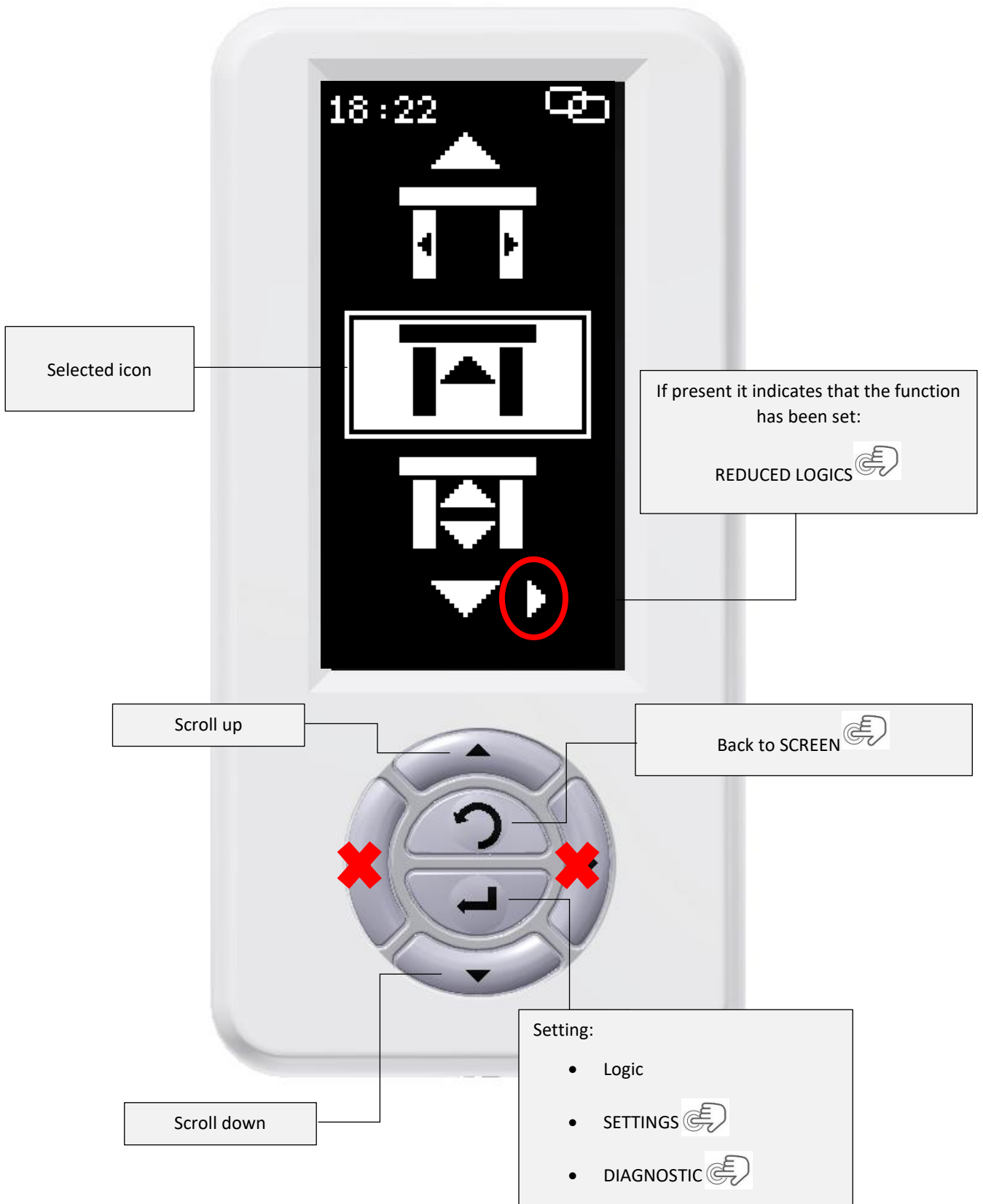

Key selection: NAVIGATION MODE MENU 

ist of icons present in the menu:

Sliding

ICONS	DESCRIPTION
	Stop close
	Stop open
	One way
	Automatic
	Partial opening One way
	Partial opening Automatic
	Partial opening Stop open
	Manual
	Partial opening Manual
	Menu SETTINGS
	Menu DIAGNOSTIC

Swing

ICONS	DESCRIPTION
	Stop close
	Stop open
	One way
	Automatic
	Manual opening
	Menu SETTINGS
	Menu DIAGNOSTIC



**DIGIDOR PROGRAMMER IS SELF-SETTING ACCORDING TO THE TYPE OF OPERATOR CONNECTED (SWING / SLIDING). IT DOES NOT REQUIRE ANY SPECIAL SETTING OR FIRMWARE DIFFERENT FROM THE AUTOMATIONS!!!**

SETTINGS



To enter the setting menu enter a password (refer to PARAMETERS SETTING ).

There are two menus:

- Menu for installer – default password: 1234
- Menu for end user – default password: 1111

**IT IS RECCOMENDED TO CHANGE THE DEFAULT PASSWORD WITH YOUR OWN PASSWORD!!!!!!!**



Icon selected

Scroll up



















Back to SCREEN

Scroll dows

Enter the selected menu

Key selection: NAVIGATION MODE MENU

List of icons of the menu **ONLY** for the installer:

ICONS	DESCRIPTION
	PARAMETERS SETTING 
	PASSWORD 
	DATE AND TIMINGS 
	CALENDAR SETTING 
	REDUCED LOGICS 
	START-UP 
	MAINTENANCE 
	LANGUAGE SELECTION 
	TAG 



**END USER MENU** is without:

- Start-up
- Maintenance
- Parameters adjustment – only setting partial opening (winter mode)

DIAGNOSTIC

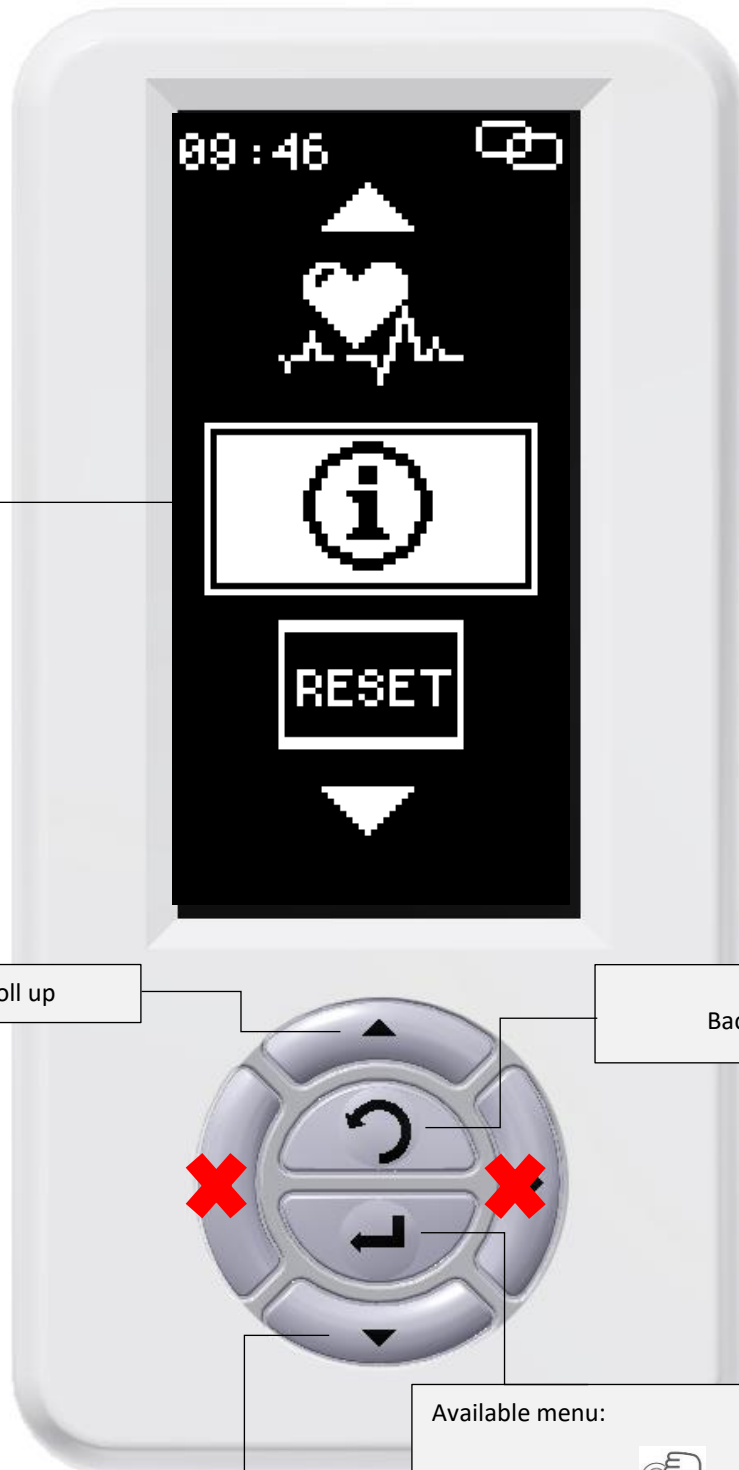

Icon selected

Scroll up

Back to SCREEN

Scroll down

Available menu:

- CHECK-UP
- INFO
- RESET

Key selection: NAVIGATION MODE MENU

CHECK-UP

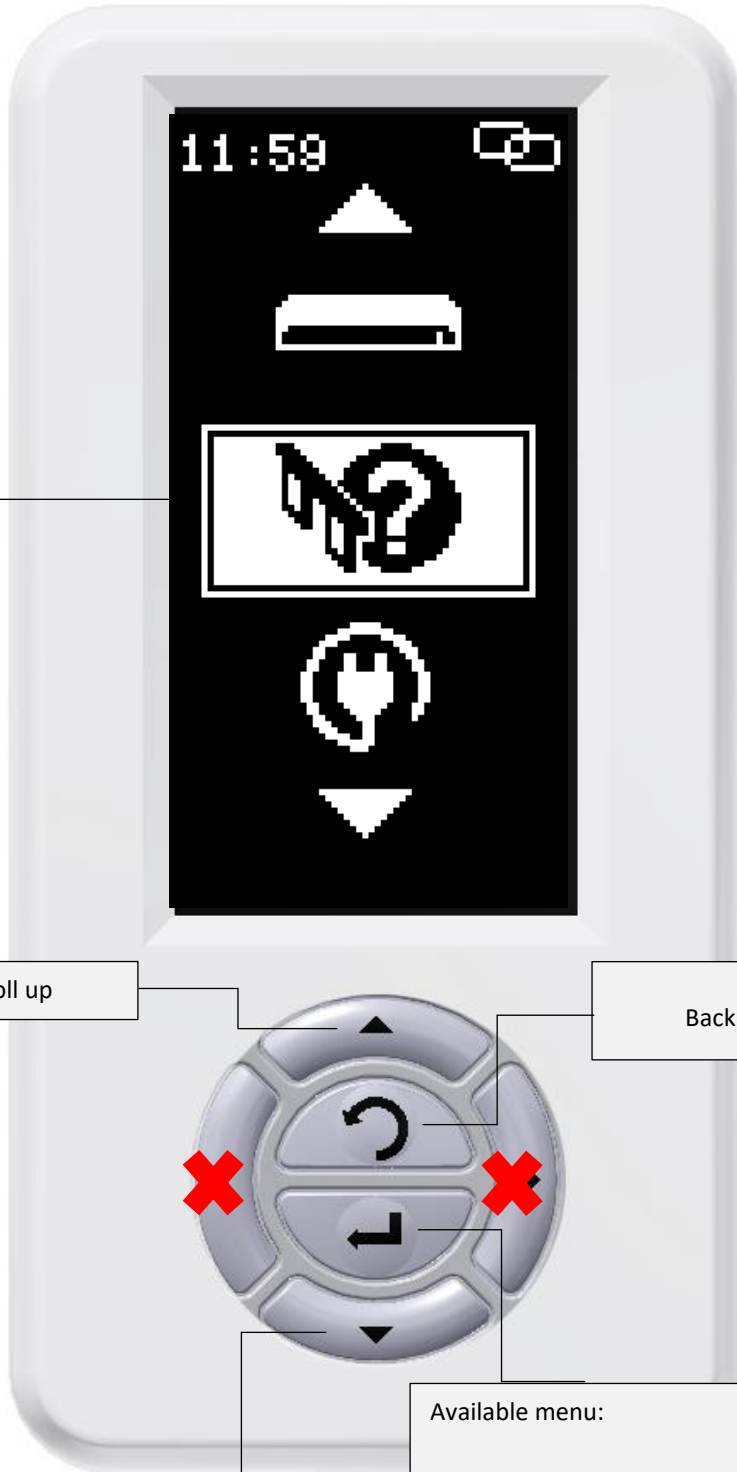

Icon selected

Scroll up

Back to DIAGNOSTI

Scorro verso il basso

Available menu:

- SENSORS' STATUS – I/O
- SYSTEM DIGNOSTIC
- POWER SUPPLY DIAGNOSTIC

Key selection: NAVIGATION MODE MENU

# SENSORS' STATUS – I/O





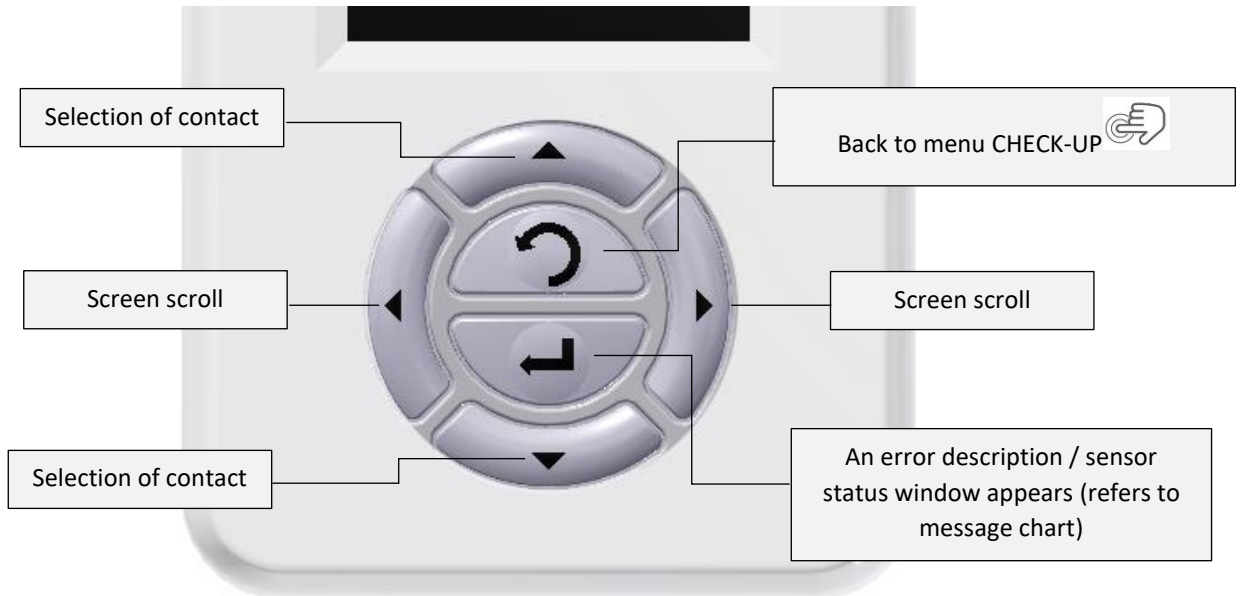
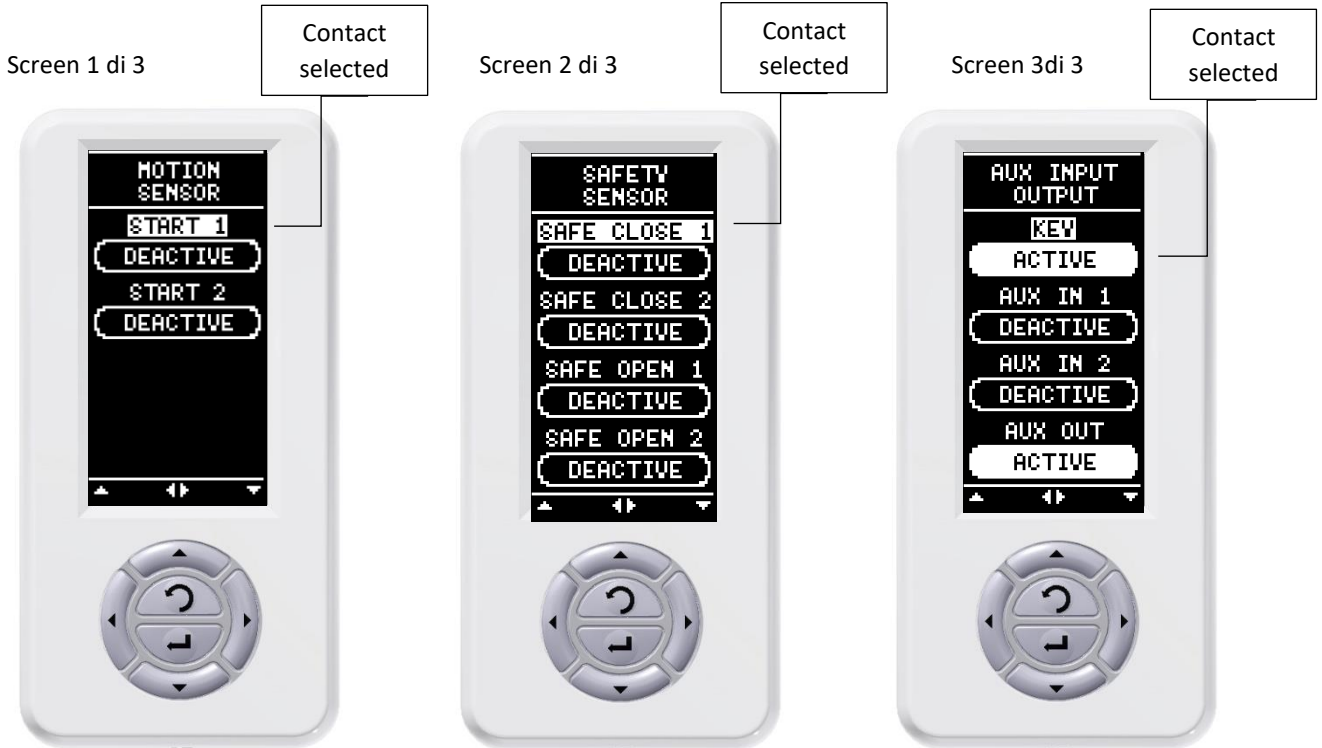

Three diagnostic screens on sensor status – I/O







Key selection: NAVIGATION MODE MENU



Messages chart screen 1 DI 3 – OPENING SENSORS:

STATUS	MESSAGE	ACTION REQUIRED
		<p>ENTER / ESC to go back</p>
		<p>ENTER / ESC to go back</p>

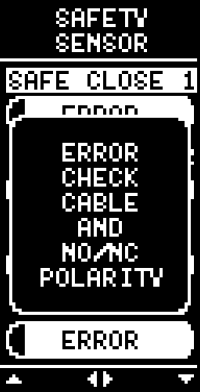
Messages chart screen 2 DI 3 – SAFETY SENSORS:

STATUS	MESSAGE	ACTION REQUIRED
		<p>ENTER / ESC to go back</p>
		<p>ENTER / ESC to go back</p>
		<p>ENTER / ESC to go back</p>

Messages chart screen 3 DI 3 – INPUT AUX-OUTPUT:

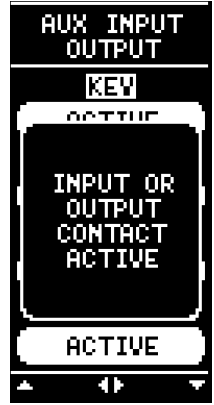
STATUS	MESSAGE	ACTION REQUIRED
		<p>ENTER / ESC to go back</p>
		<p>ENTER / ESC to go back</p>

SYSTEM DIGNOSTIC



Two diagnostic screens:

Screen 1/2

Screen 2/2

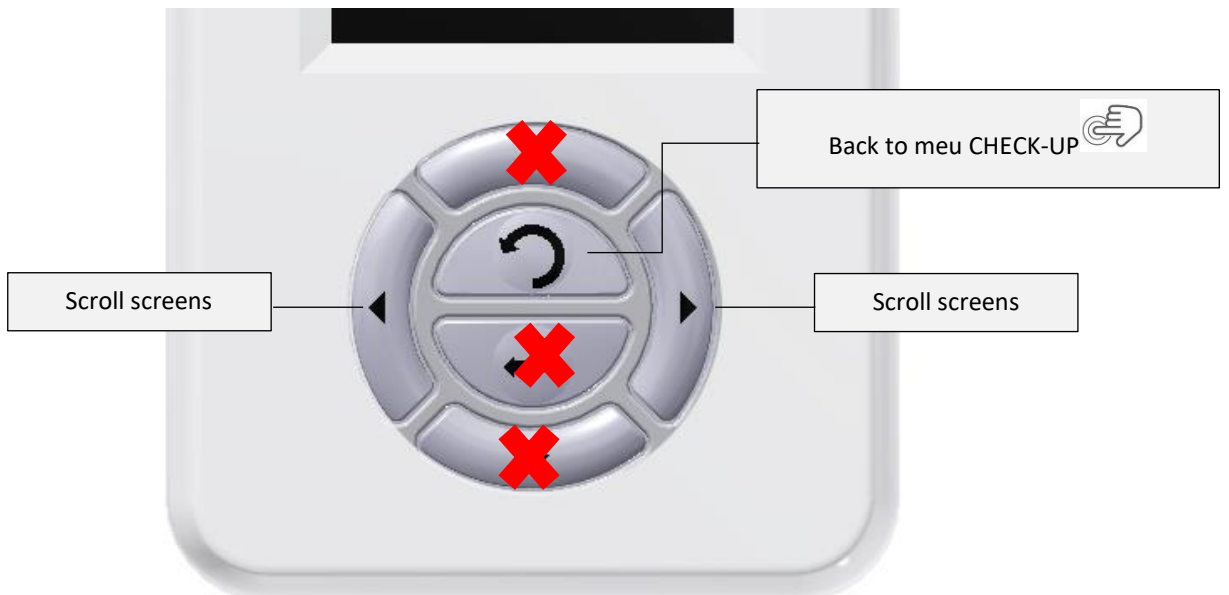
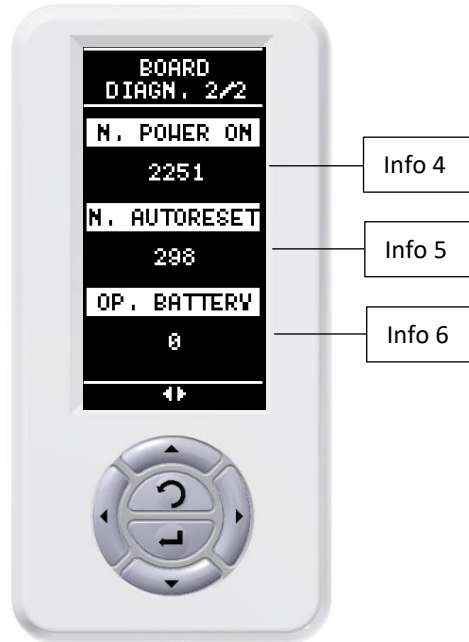
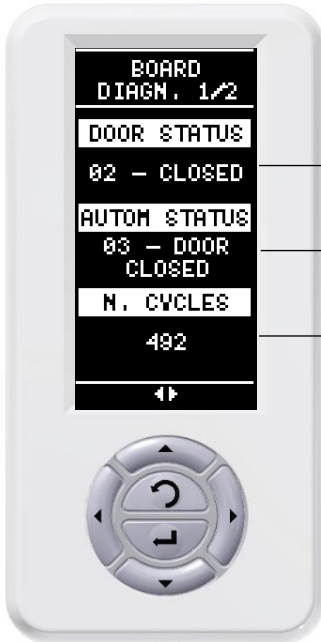

Key selection: NAVIGATION MODE MENU



# POWER SUPPLY DIAGNOSTIC



Two diagnostic screens:

Screen 1/2

Screen 2/2

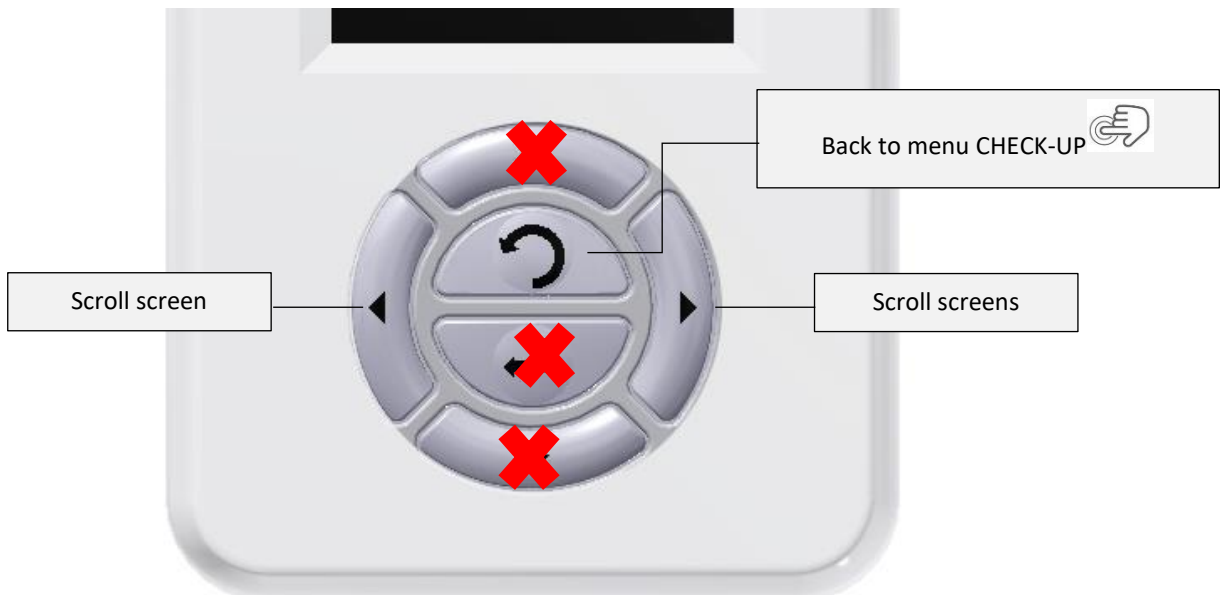

Key selection: NAVIGATION MODE MENU



INFO



Four system information screens:

Screen 1 di 4

Screen 2 di 4

Screen 3 di 4

Screen 4 di 4

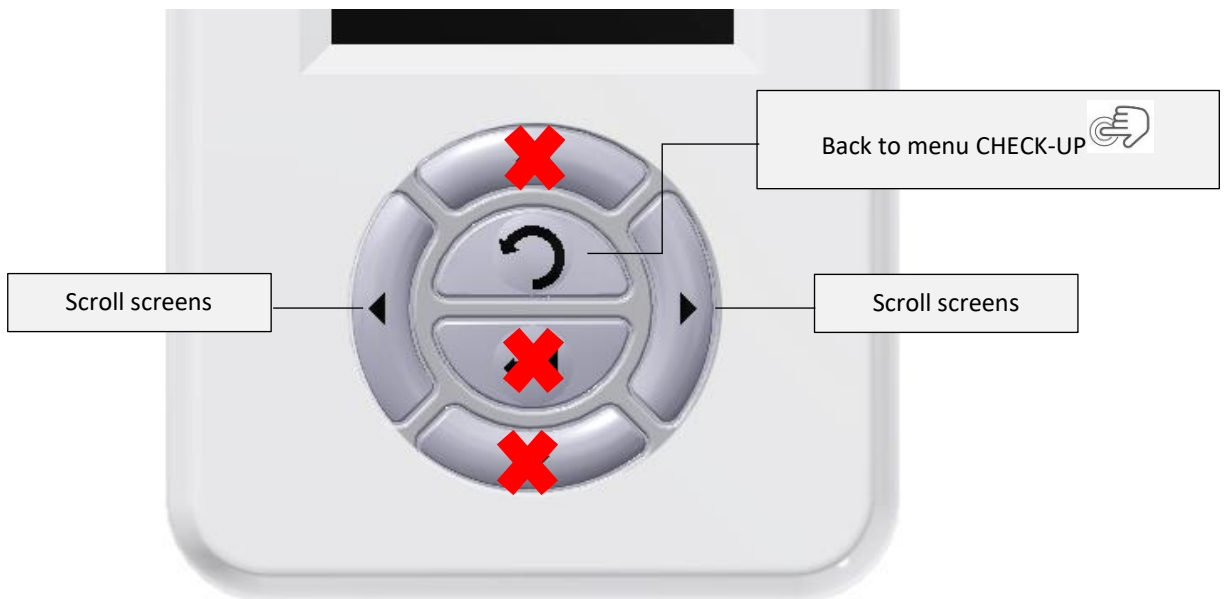

RESET



NOTE: pressing key "ESC" during reset allows to go back to "First main screen", but if the procedure is not finished, on the display will NOT appear the logic selected until the procedure has been executed.

Key selection: NAVIGATION MODE MENU 

LOG



To activate LOG please follow the instructions:



**ATTENTION!!!! TO ACTIVATE LOG PROPERLY YOU MUST SET DATE AND TIMING**

(To adjust set DATE AND TIMINGS  )

1. Plug the cable Micro USB / USB (PF37.30) and a standard USB key storage. Once plugged check display shows icon that means the key is recognized.

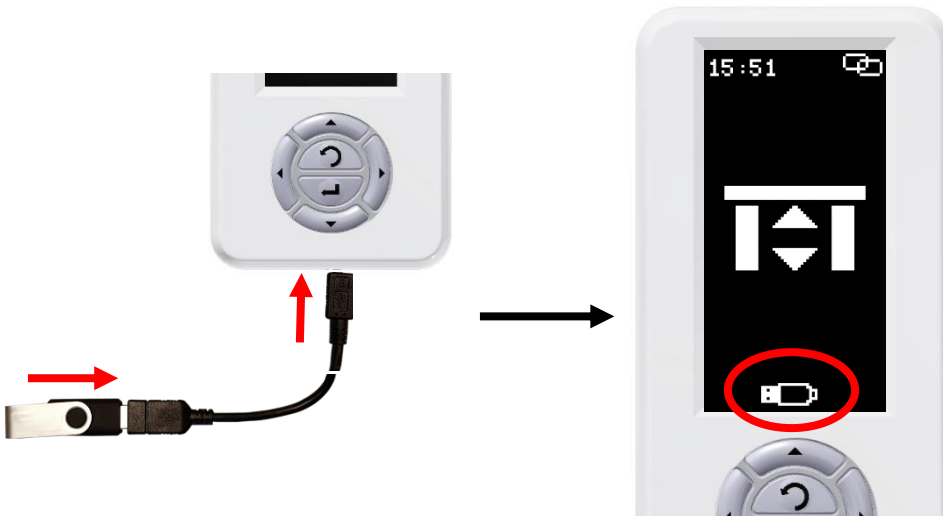

2. Enter menu DIAGNOSTIC   and follow the instructions:

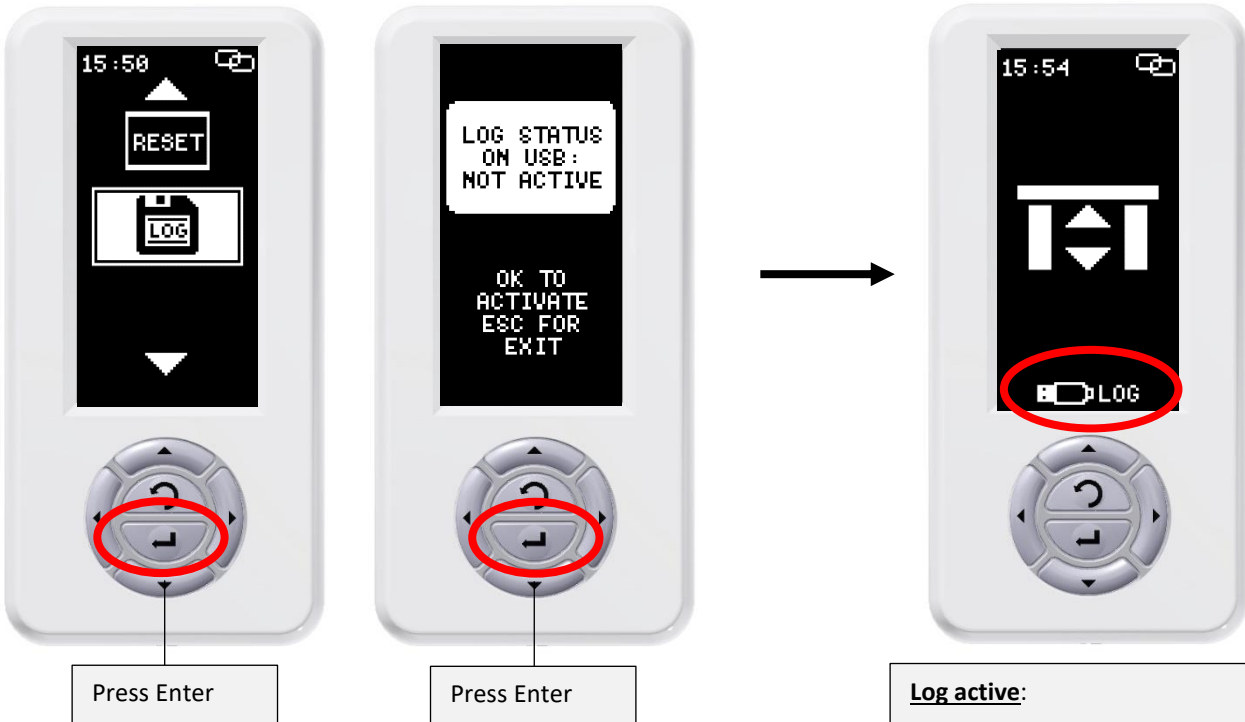

Press Enter

Press Enter

**Log active:**

Once activate, Digidor will download the diagnostic files (visible on Laptop) inside the USB storage key connected.

Key selection: NAVIGATION MODE MENU 

To deactivate LOG and download files on Laptop please follow the instructions:

1. Enter menu DIAGNOSTIC   and follow instructions:

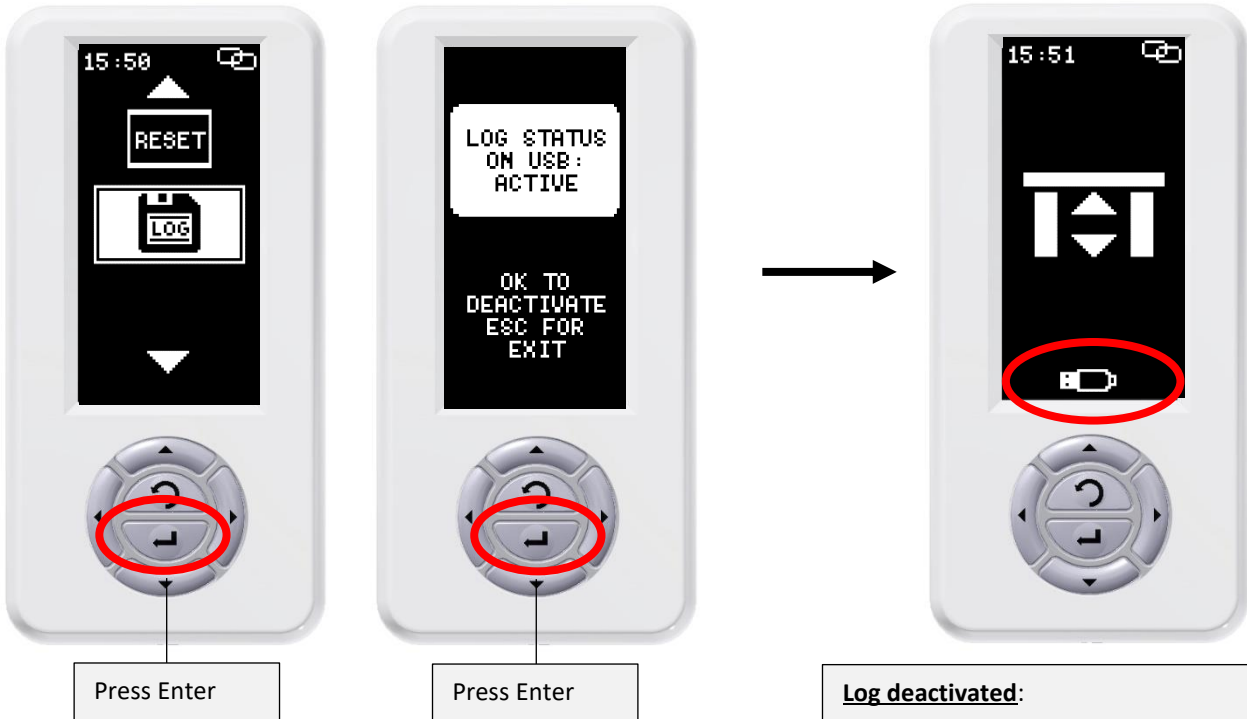

2. Remove the USB key as indicated:

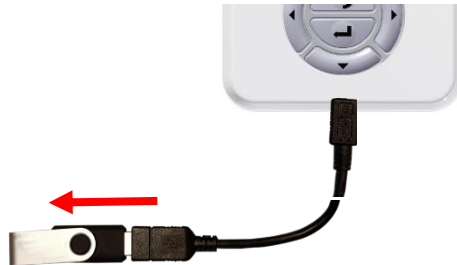

3. Once plugged in the laptop files will appear as per the following image:

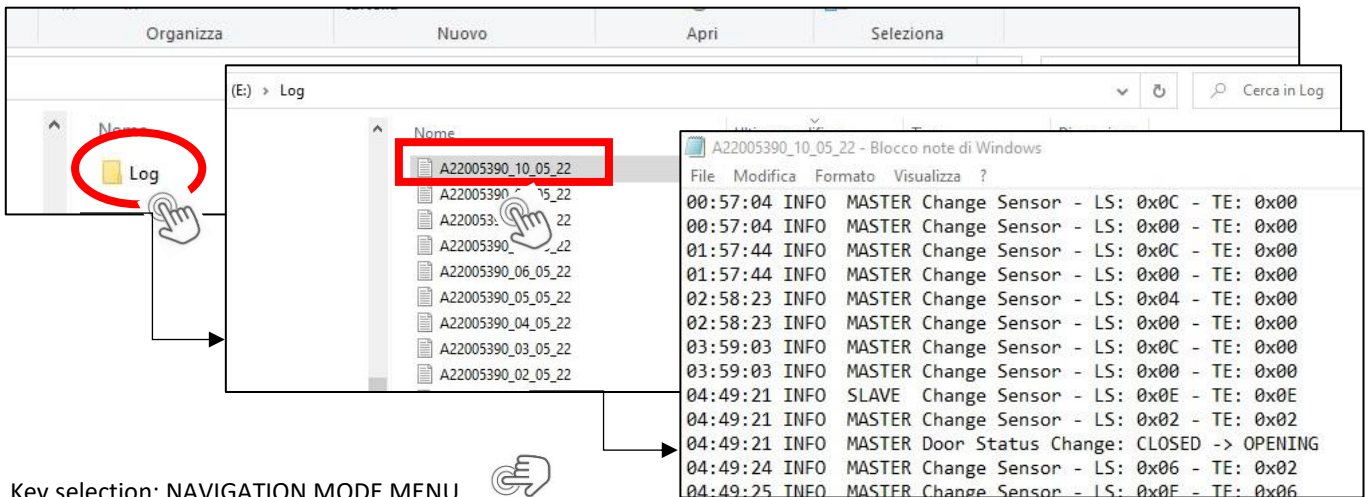

Key selection: NAVIGATION MODE MENU 

## PARAMETERS SETTING



On the menu "Parameters setting" it is possible to find the complete list of parameters useful to adjust the operator according to the norms and own preferences.

There are three setting mode:

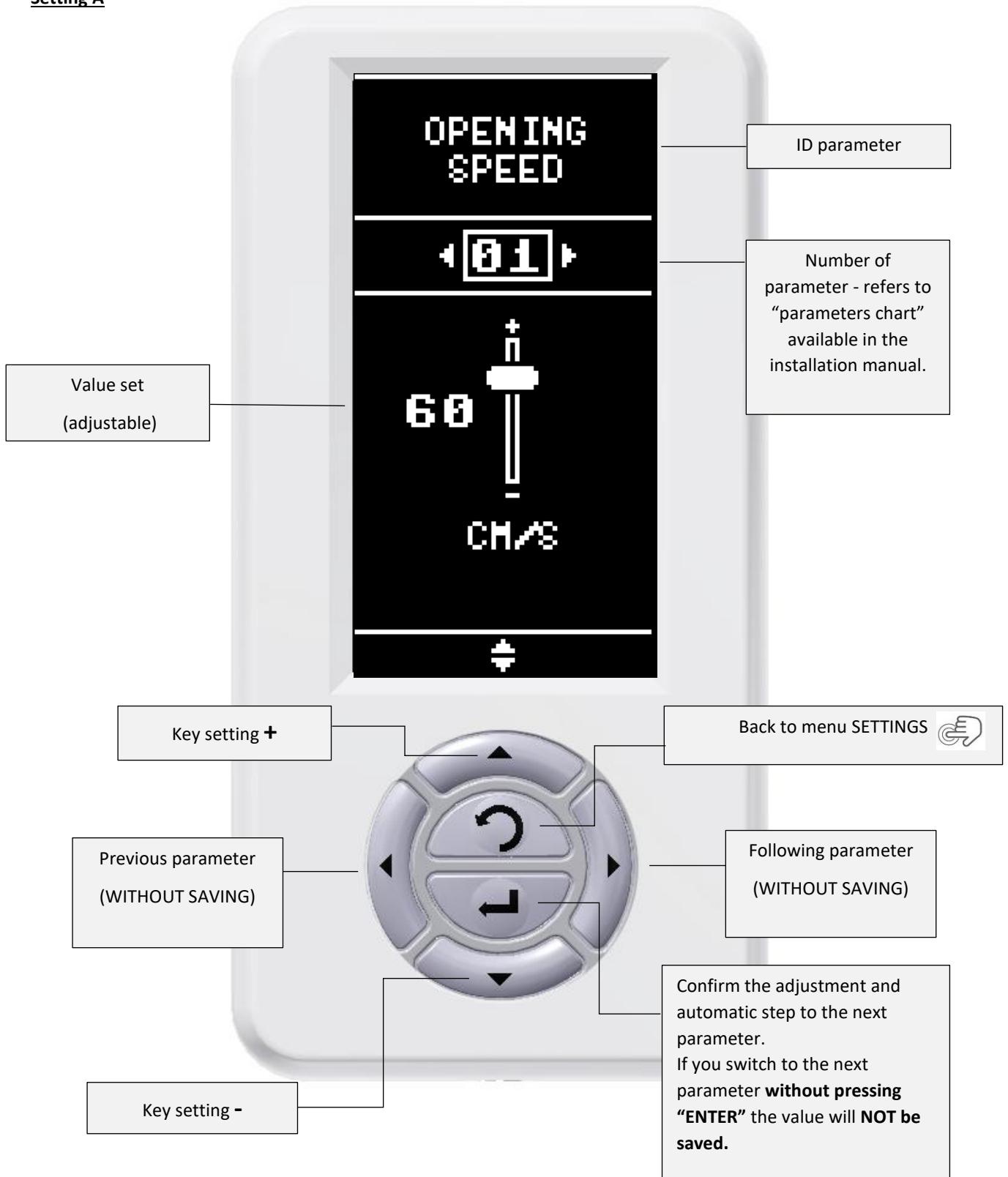
Setting A

Setting B



ID parameter

Number of parameter - refers to "parameters chart" available in the installation manual.

Available function

BATTERY MANAGEMENT	BATTERY MANAGEMENT	BATTERY MANAGEMENT
◀ 33 ▶	◀ 33 ▶	◀ 33 ▶
1	2	3
NORMAL FUNCTION	EMERGENCY FUNCTION	SAFETY FUNCTION WITH CAP. CONTROL
⬆	⬆	⬆

Scroll available functions

Back to menu SETTINGS

Previous parameter (WITHOUT SAVING)

Following parameter (WITHOUT SAVING)

Scroll available functions

Confirm the adjustment and automatic step to the next parameter. If you switch to the next parameter **without pressing "ENTER"** the value will **NOT be saved**.

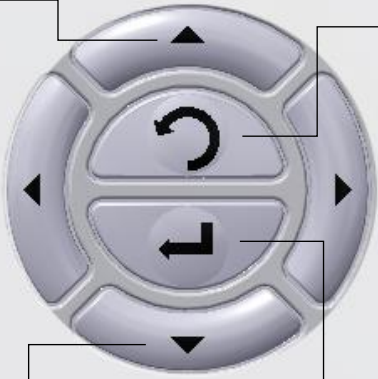

Key selection: NAVIGATION MODE MENU

Setting C

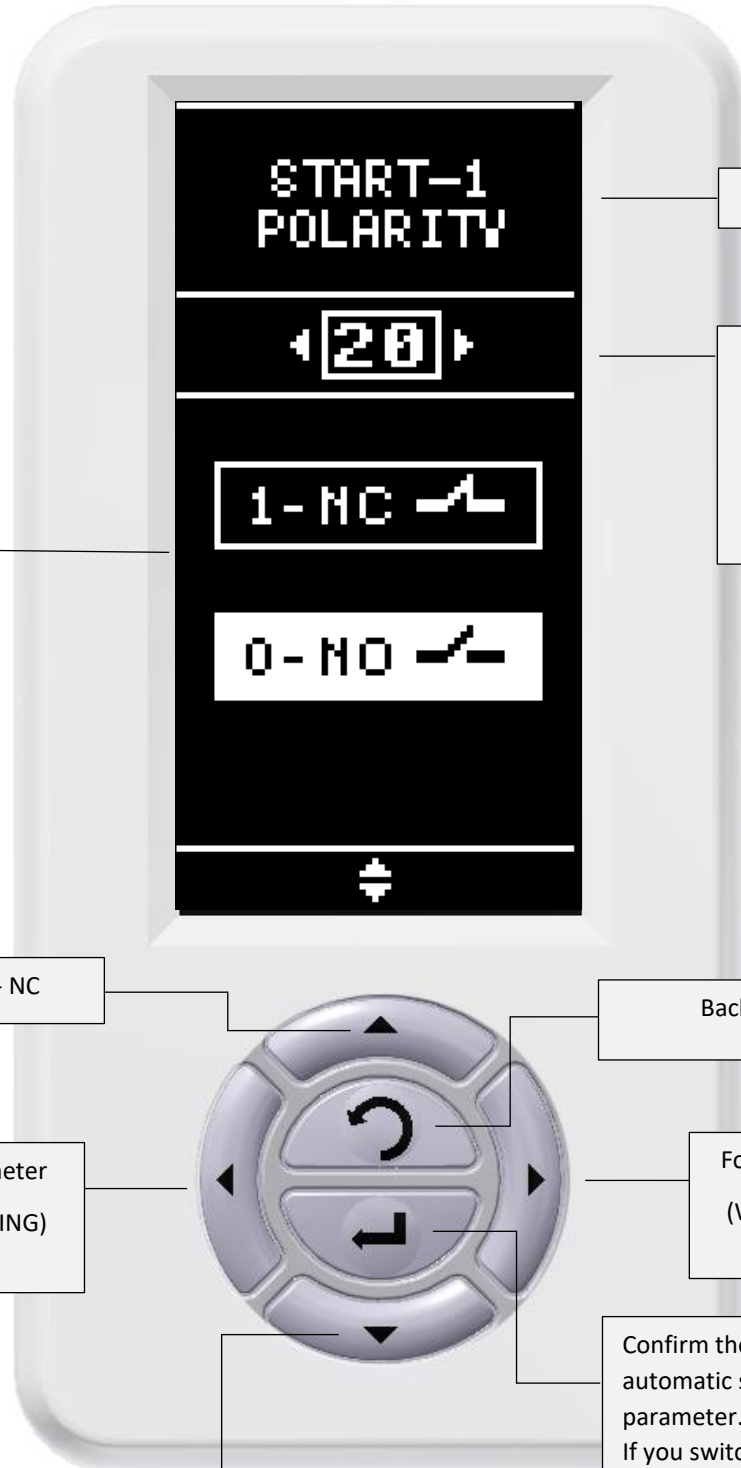

Setting contact N/O –  
N/C

ID parameter

Number of  
parameter - refers to  
“parameters chart”  
available in the  
installation manual.

1 - NC

Back to menu SETTINGS 

Previous parameter  
(WITHOUT SAVING)

Following parameter  
(WITHOUT SAVING)

0 – N/O

Confirm the adjustment and  
automatic step to the next  
parameter.  
If you switch to the next  
parameter **without pressing**  
“ENTER” the value will **NOT** be  
saved.

Key selection: NAVIGATION MODE MENU 

PASSWORD

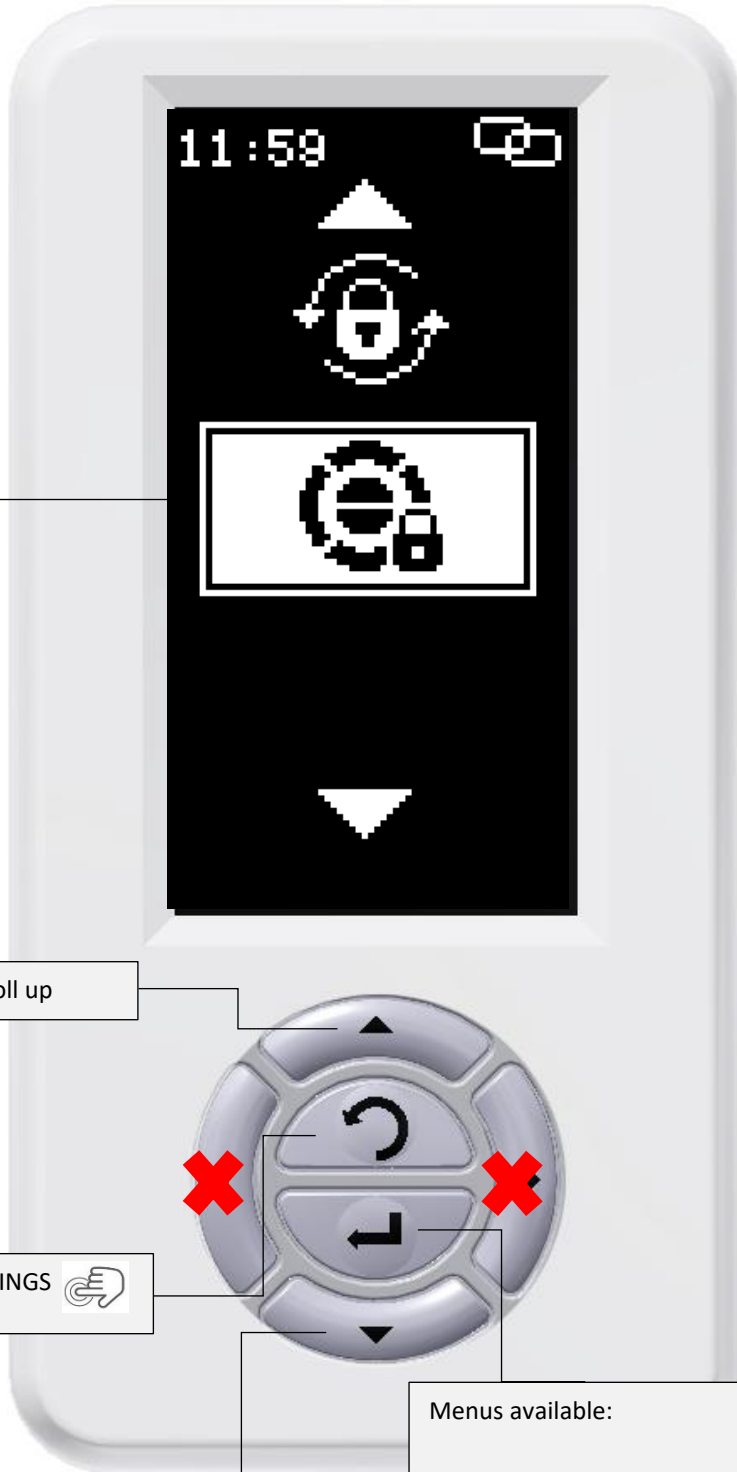

There are two passwords:

1.Password for installer  
Default password: **1234**

2.Password for end user  
Default password: **1111**



IT IS RECCOMENDED TO CHANGE THE DEFAULT PASSWORD WITH YOUR OWN

ONLY INSTALLER HAS THE POSSIBILITY TO MODIFY BOTH PASSWORDS.

END USER WILL HAVE CHANCE TO MODIFY ONLY THE END USER PASSWORD.

Icon selected

Scroll up

Back to menu SETTINGS

Scroll down

- Menus available:
- MODIFY PASSWORD
  - PASSWORD TO LOCK THE KEYBOARD

Key selection: NAVIGATION MODE MENU

MODIFY PASSWORD



1 - INSTALLER



Password view set

Scroll increasing numbers

Scroll left number

Scroll decreasing numbers

Back to menu SETTINGS

Scroll right number



Confirm each single number and proceed to the following, once all numbers are confirmed you will pass to End User password set-up: "USER PASSWORD".  
If you want to modify it, repeat same procedure otherwise press 4 times ENTER and go back to menu  
MODIFY PASSWORD

Key selection: NAVIGATION MODE MENU

2 – END USER

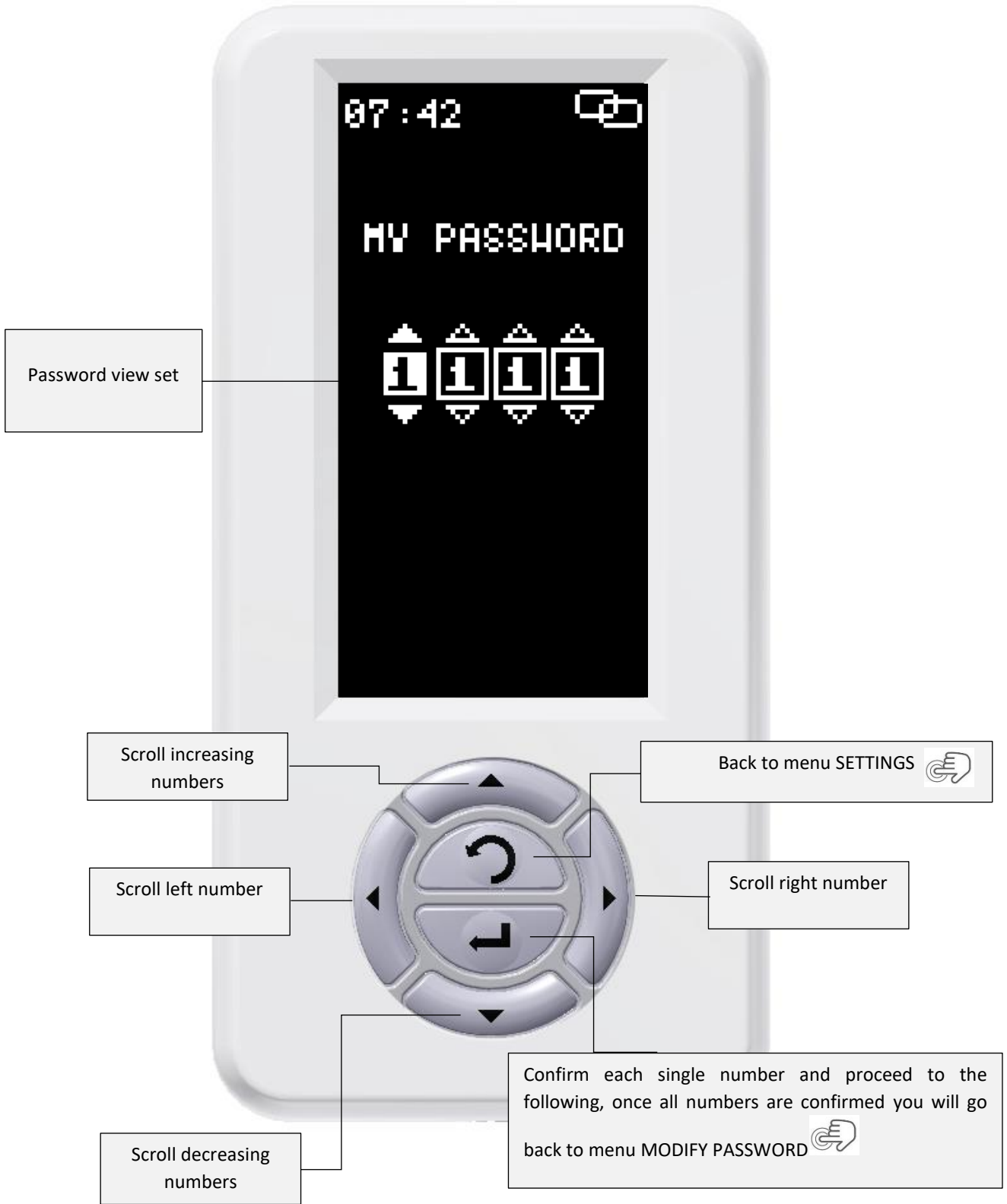

Key selection: NAVIGATION MODE MENU

PASSWORD TO LOCK THE KEYBOARD

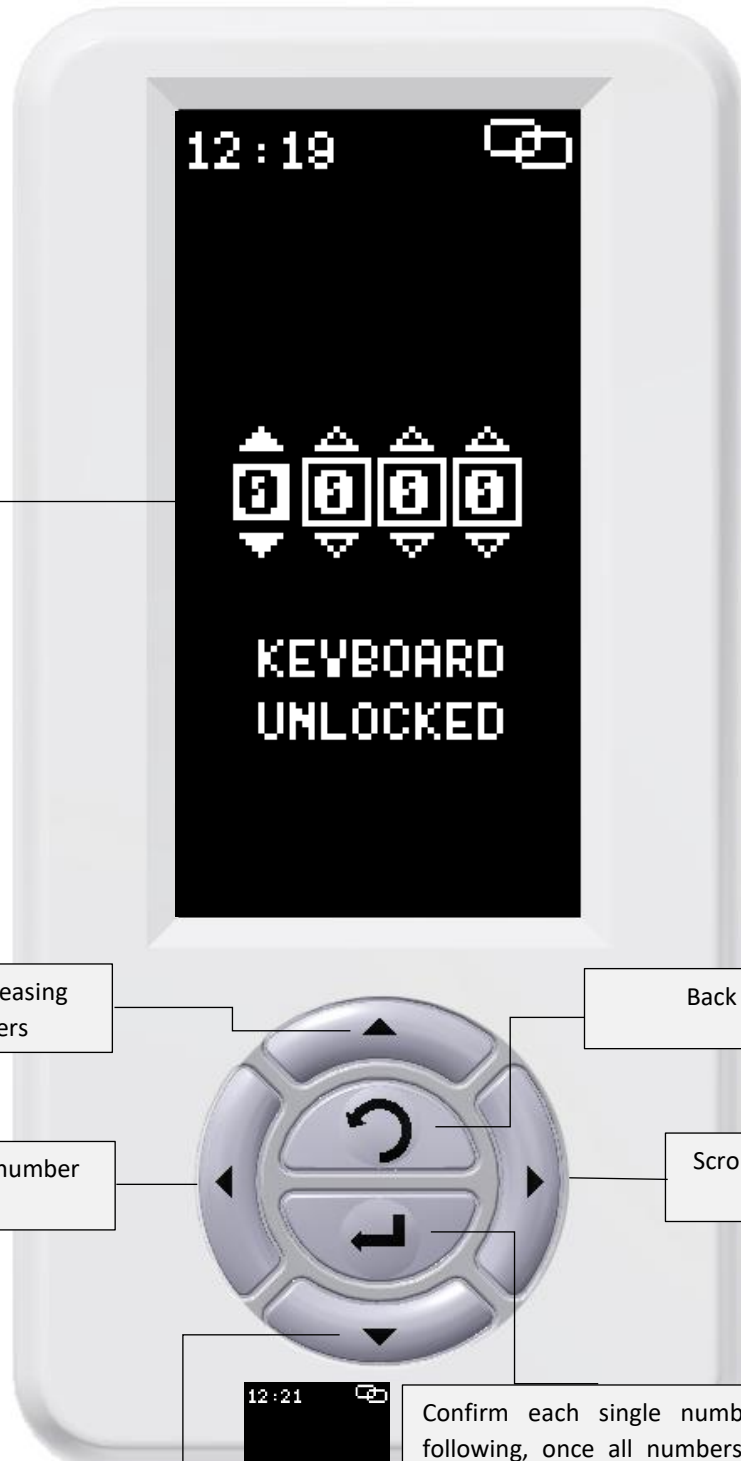

Default value:  
**0000**  
It means keybord  
unlocked.

Scroll increasing  
numbers

Back to menu SETTINGS

Scroll left number

Scroll right number

Scroll decreasing  
numbers

Confirm each single number and proceed to the following, once all numbers are confirmed I set the keyboard lock and go back to menu:  
**MODIFY PASSWORD**

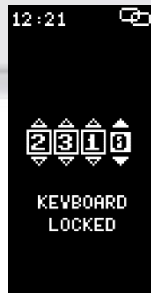

Key selection: NAVIGATION MODE MENU

DATE AND TIMINGS

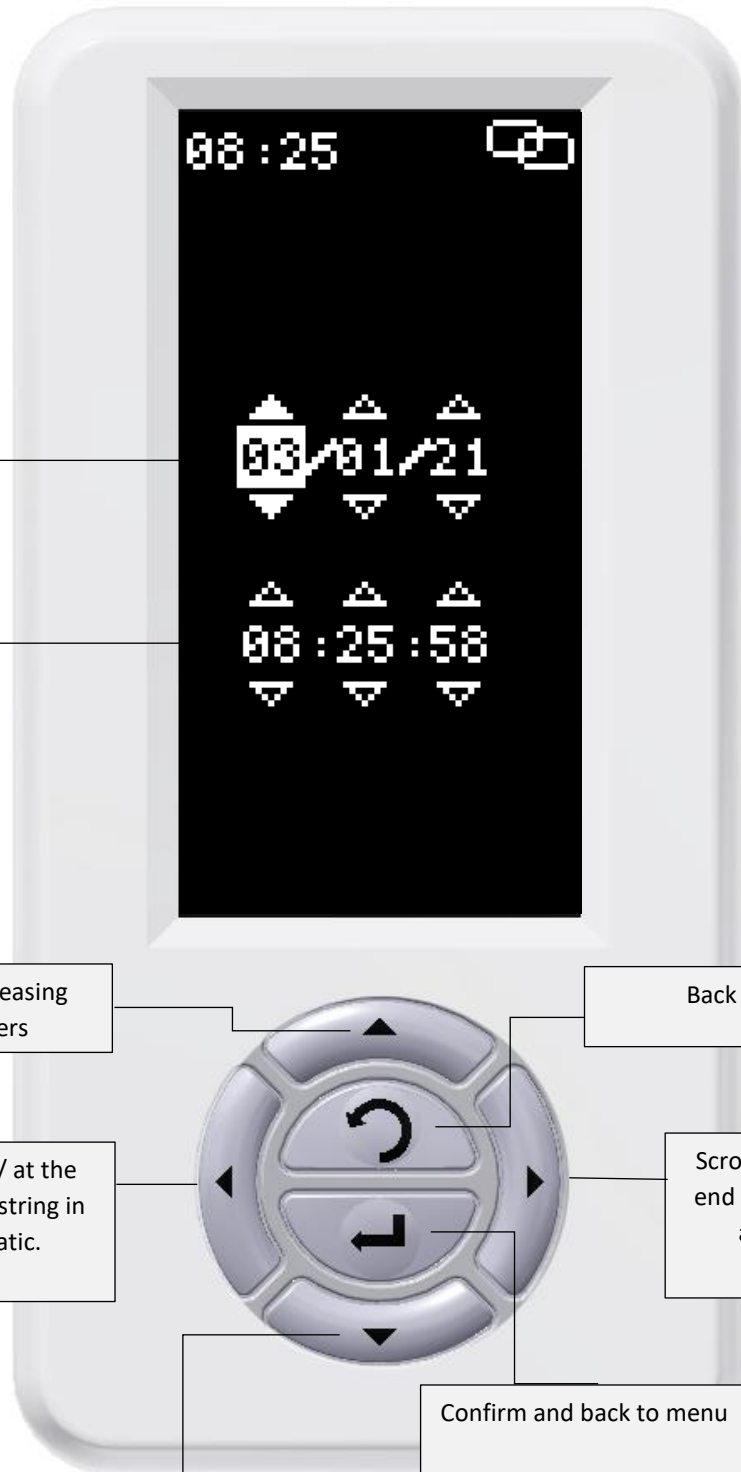

Date set

Timing set

Scroll increasing numbers

Scroll left / at the end of the string in automatic.

Scroll decreasing numbers

Back to menu SETTINGS

Scroll right / at the end of the string in automatic.

Confirm and back to menu

Key selection: NAVIGATION MODE MENU

CALENDAR SETTING



**Step 1:**

Select Day of the Week

Selection area

Back to menu

Browsing days

Confirm and go to following screen.

**Step 2:**

Select time slots to set – N.4 timings for each day of the week

Scroll up

Back to previous screen

Select - Set

Scroll down

Deselect - Remove setting

Confirm and go to following screen.

**Step 3:**

Set the time

Go back to the previous screen

Browsing – see paragraph: DATE AND TIMINGS

Confirm and go to following screen.

**Step 4:**

Set the logic

Go back to the previous screen

Browsing – see paragraph: SELECTION MENU': LOGIC – SETTINGS - DIAGNOSTIC

Confirm and go back to step 2

From this screen possible to set the other time slots otherwise press "ESC" and back to step 1

At this point the time slot will be set **BUT NOT ACTIVE!!!!** When pressed the "ESC" button, it will come a new screen that will ask to confirm.

If confirmed, at that point the function will be activated otherwise it will remain set and t can be activated later.

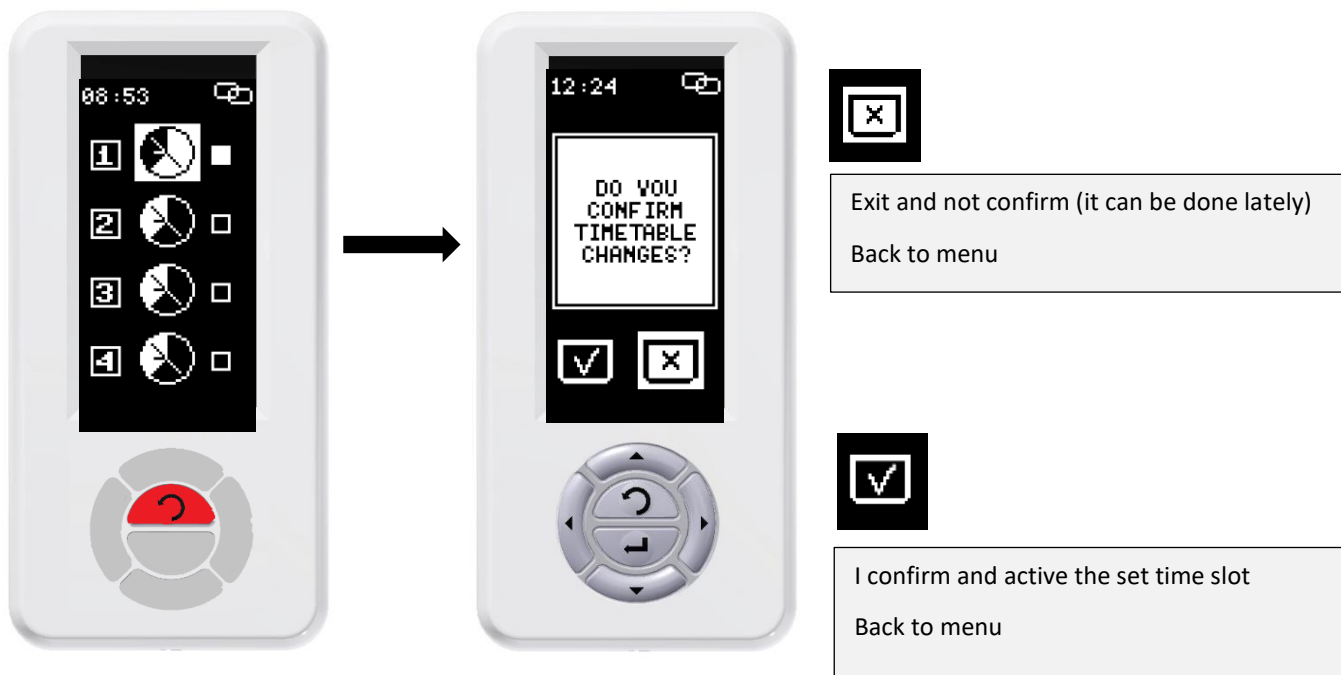

REDUCED LOGICS

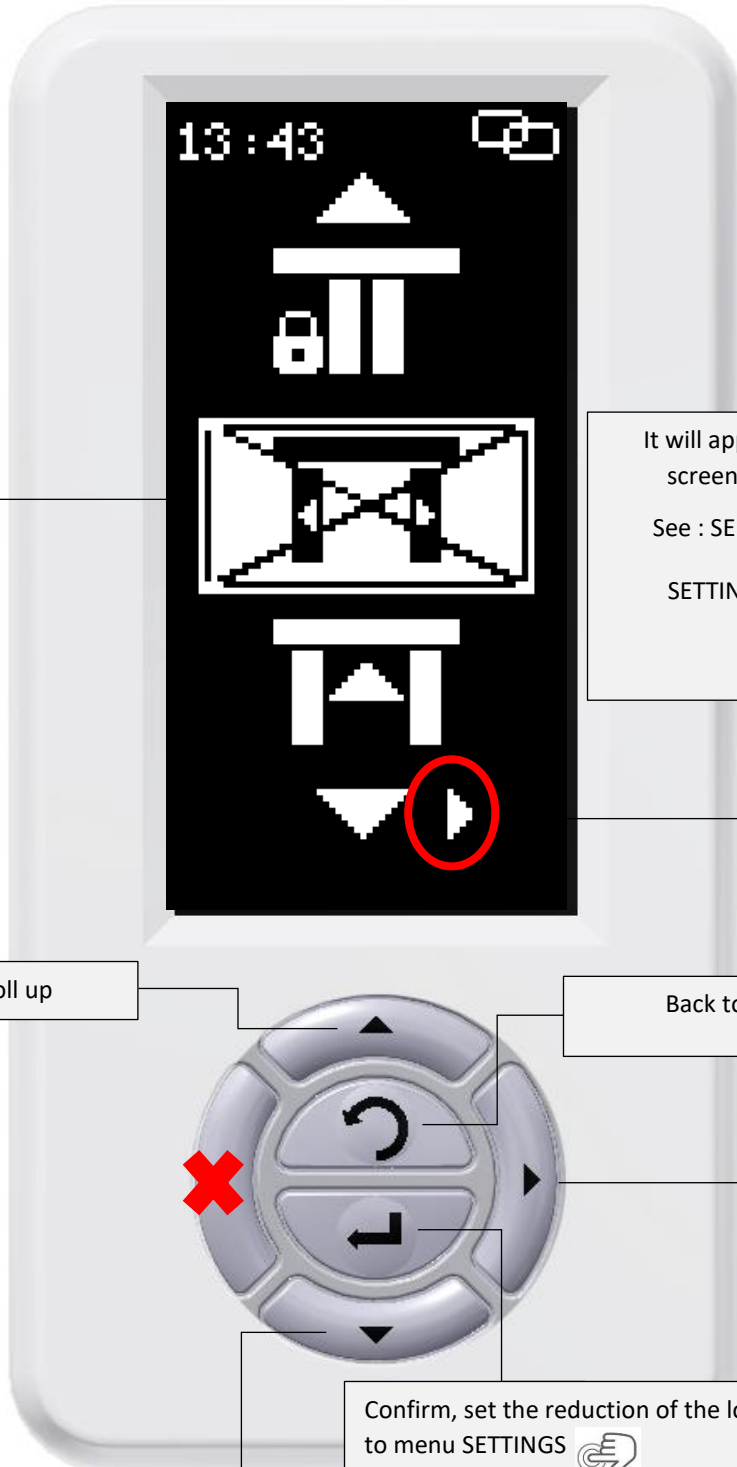

Logic cancelled

It will appear on the logic selection screen to indicate a reduction.  
See : SELECTION MENU' : LOGIC – SETTINGS - DIAGNOSTIC

Scroll up

Back to menu SETTINGS

Active / Not Active the logic selected

Confirm, set the reduction of the logics and go back to menu SETTINGS

Scroll down

Key selection: NAVIGATION MODE MENU

START-UP

SET-UP



Scroll selection up

Back to menu SETTINGS

I scroll through the previous screens

I scroll through the next screens

Confirm and move to the next screen

Scroll selection down



**THE BROWSING  
MODE AND  
FUNCTIONALITY  
OF THE KEYS IS  
THE SAME IN  
EACH SCREEN**

Key selection NAVIGATION MODE MENU



**NOTE: The selected factory settings comply with the EN16005**

Commissioning consists of a series of wizards specified below:

1° Operator' series detection, operator must only wait signal



2° Set safety in closing of the internal sensor S2. Confirm with ENTER



3° Set the test for safety in closing of the internal sensor S2. Confirm with ENTER



**ATTENTION!!!! NOT SELECTING THE CONTACT MAKES THE INPUT NOT COMPLIANT WITH EN16005.**

4° Set safety in closing of the external sensor S1. Confirm with ENTER



5° Set the test for safety in closing of the external sensor S1. Confirm with ENTER



**ATTENTION!!!! NOT SELECTING THE CONTACT MAKES THE INPUT NOT COMPLIANT WITH EN16005.**

6° Set safety in opening of right sensor S3. Confirm with ENTER



7° Set the test for safety in opening of the right sensor S3.  
Confirm with ENTER



8° Set safety in opening of the left sensor S4.  
Confirm with ENTER



9° Set the test for safety in opening of the left S4.  
Confirm with ENTER



**ATTENTION!!!! NOT SELECTING THE CONTACT MAKES THE INPUT NOT COMPLIANT WITH EN16005.**

**ATTENTION!!!! NOT SELECTING THE CONTACT MAKES THE INPUT NOT COMPLIANT WITH EN16005.**

10° Set polarity test safety contact in closing.  
Confirm with ENTER



11° Set polarity test safety contact in opening.  
Confirm with ENTER



12° Diagnostic screen, if there are no error signals press ENTER to continue otherwise double-check the settings made previously (NO/NC – wiring)



13° If present Set type of electromechanical lock (OPTIONAL). Confirm with ENTER



14° if present Set the recharging power battery kit (OPTIONAL). Confirm with ENTER



15° If fitted set the kit elastic CO48 . Confirm with ENTER



16° Press ENTER to run L.P.

Once started, the selector will communicate with operator on the different procedures that is running, through a series of diagnostic screens.

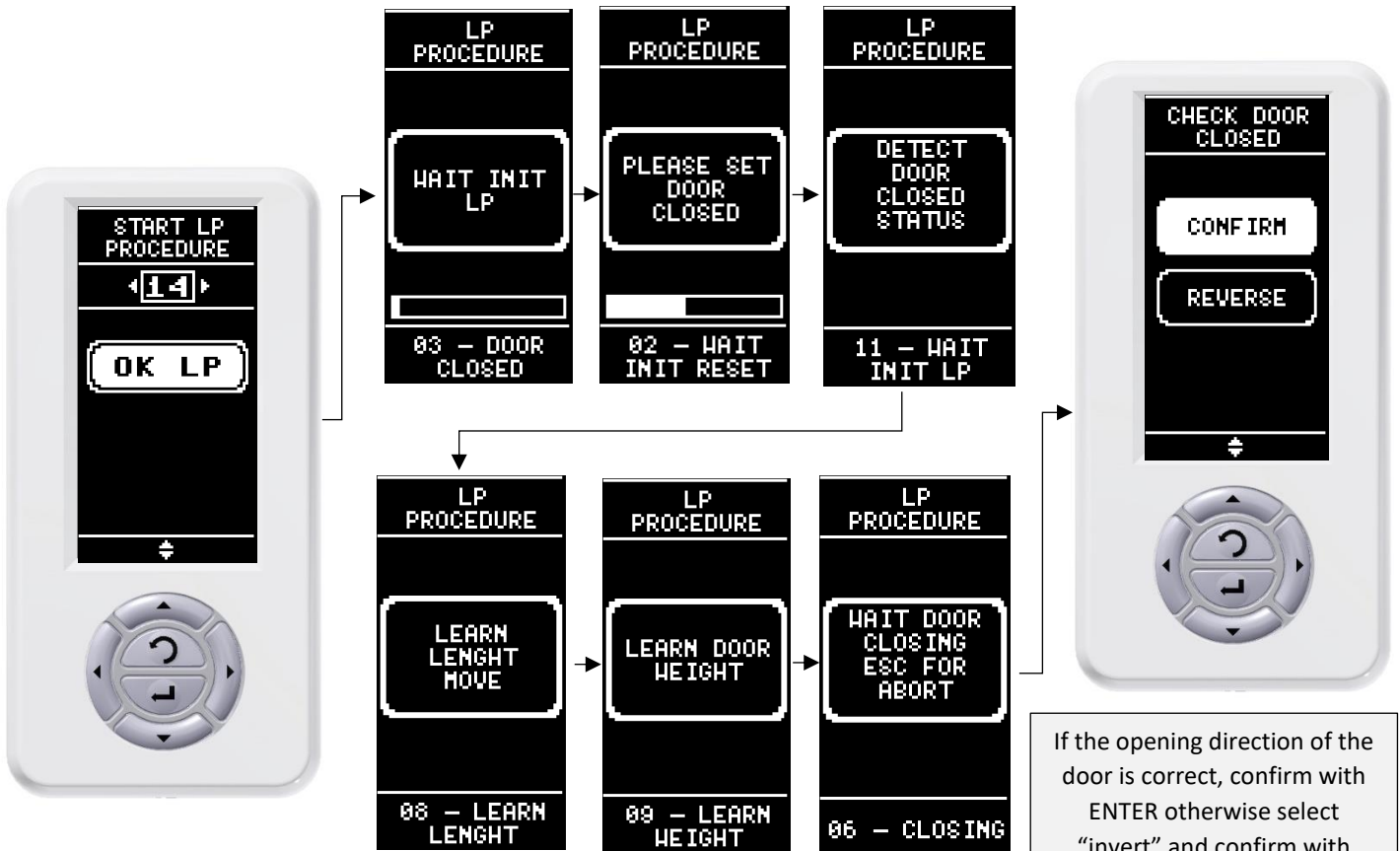

If the opening direction of the door is correct, confirm with ENTER otherwise select "invert" and confirm with ENTER. End of the START-UP.

MAINTENANCE



Icon selected

Scroll up

Back to menu SETTINGS

Scroll down

Menus available:

- FIRMWARE UPDATE
- SET A DEFAULT

Key selection: NAVIGATION MODE MENU

# FIRMWARE UPDATE



By using an adapter cable Micro USB / USB (PF37.30), through a normal USB stick, it is possible to upgrade the firmware of the selector and main control boards.

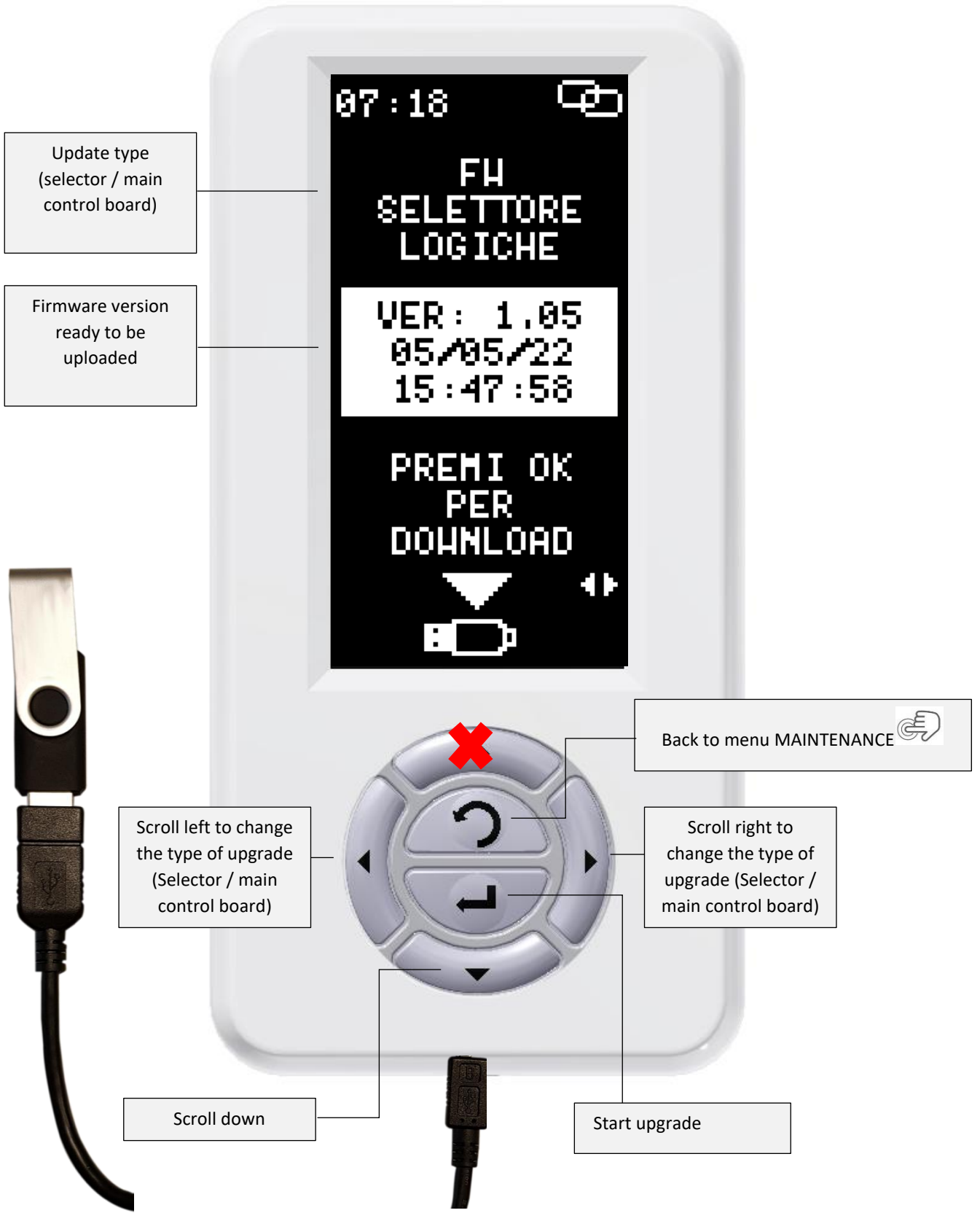

Update type (selector / main control board)

Firmware version ready to be uploaded

Scroll left to change the type of upgrade (Selector / main control board)

Back to menu MAINTENANCE

Scroll right to change the type of upgrade (Selector / main control board)

Scroll down

Start upgrade

Key selection: NAVIGATION MODE MENU

Plug the cable Micro USB / USB (PF37.30) and a standard USB key storage with firmware that must be upgraded:

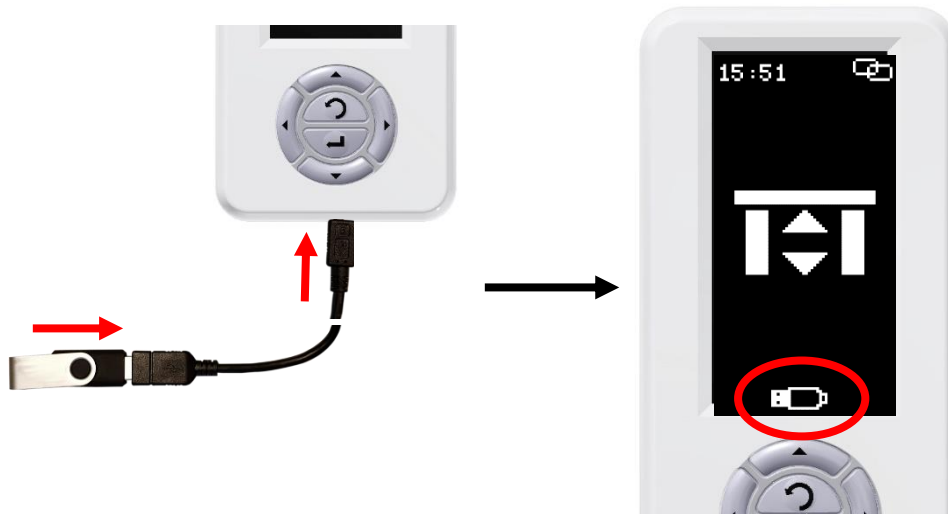

Updates selector firmware:

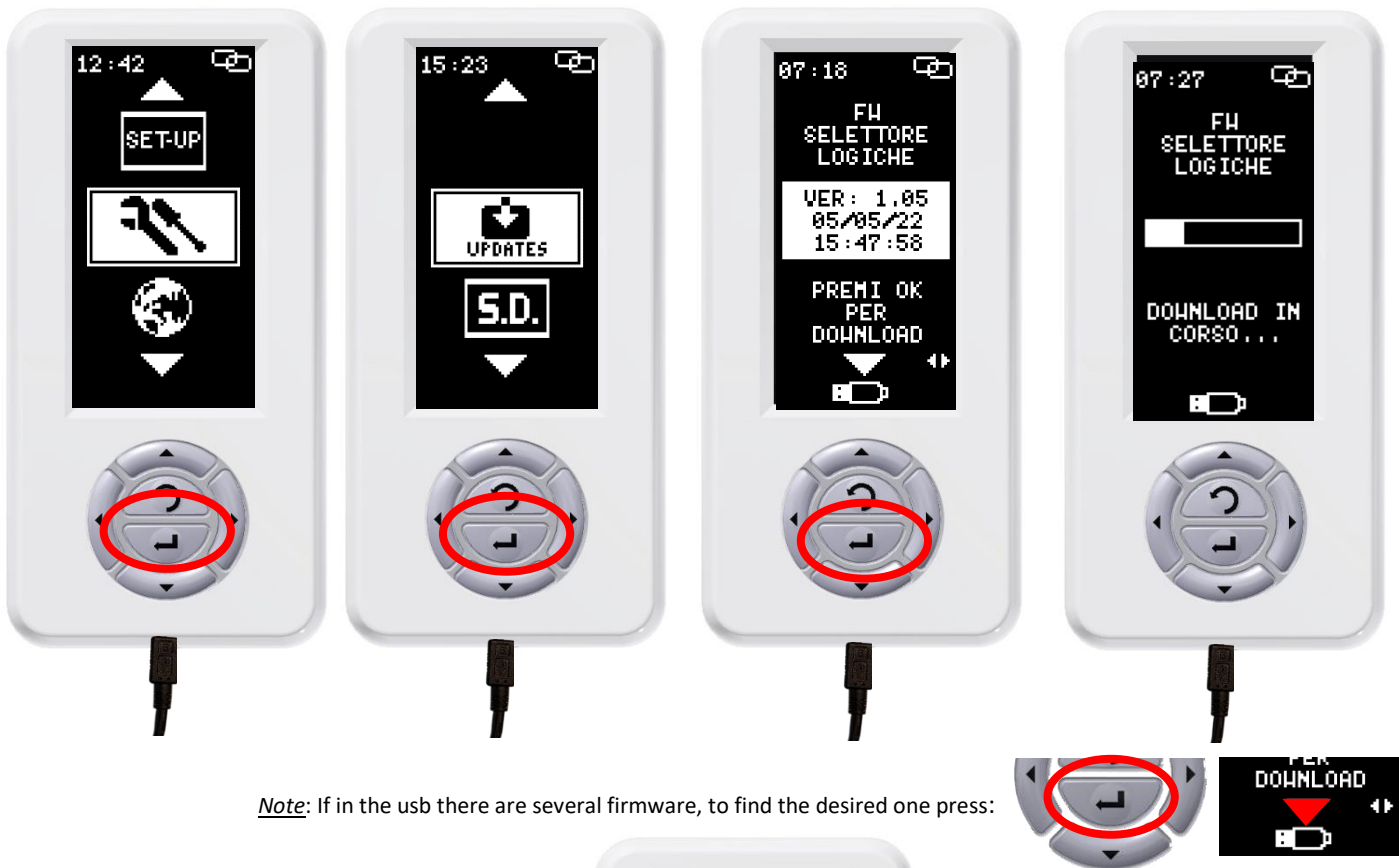

Note: If in the usb there are several firmware, to find the desired one press:

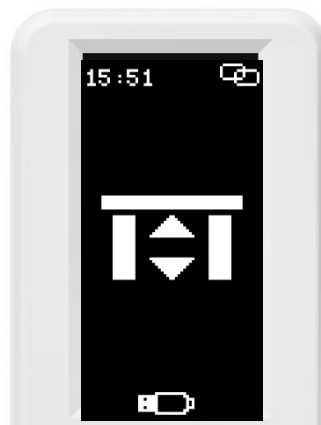

Update T.E. board:

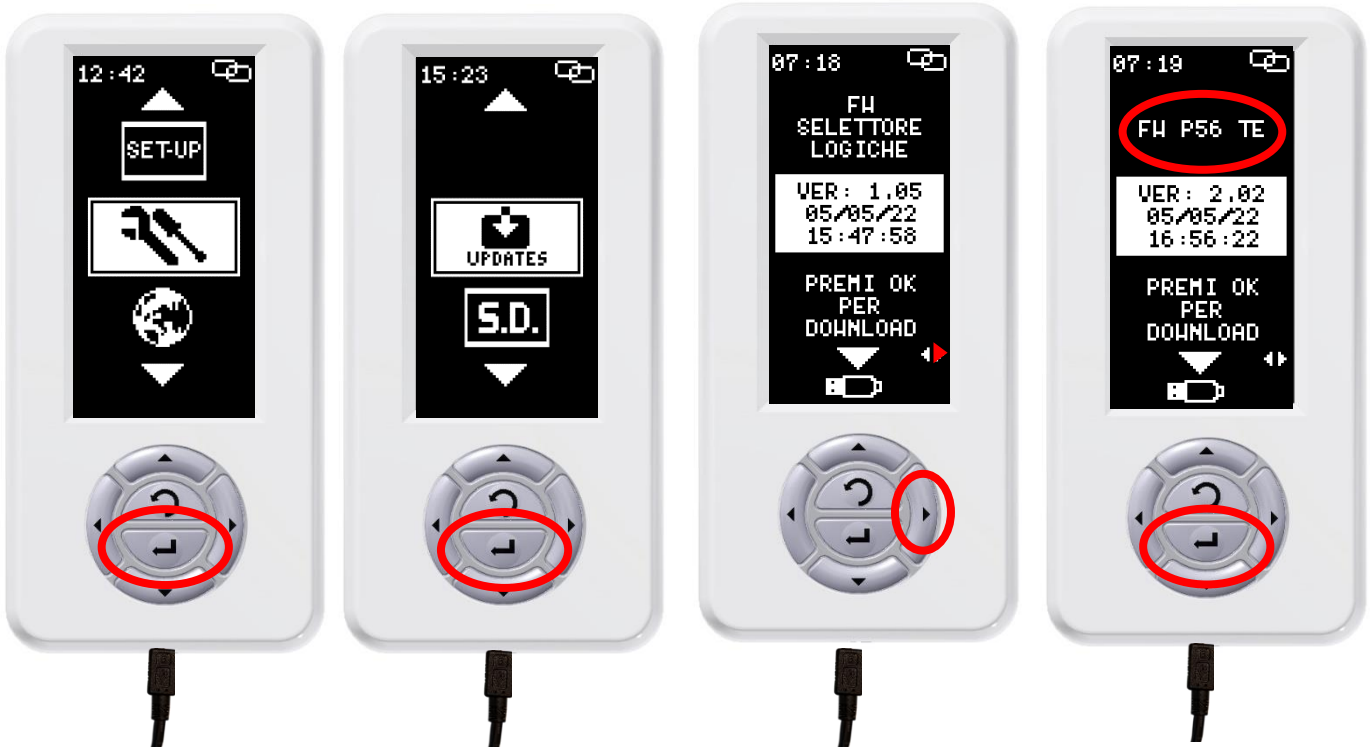

Note: If in the usb there are several firmware, to find the desired one press:

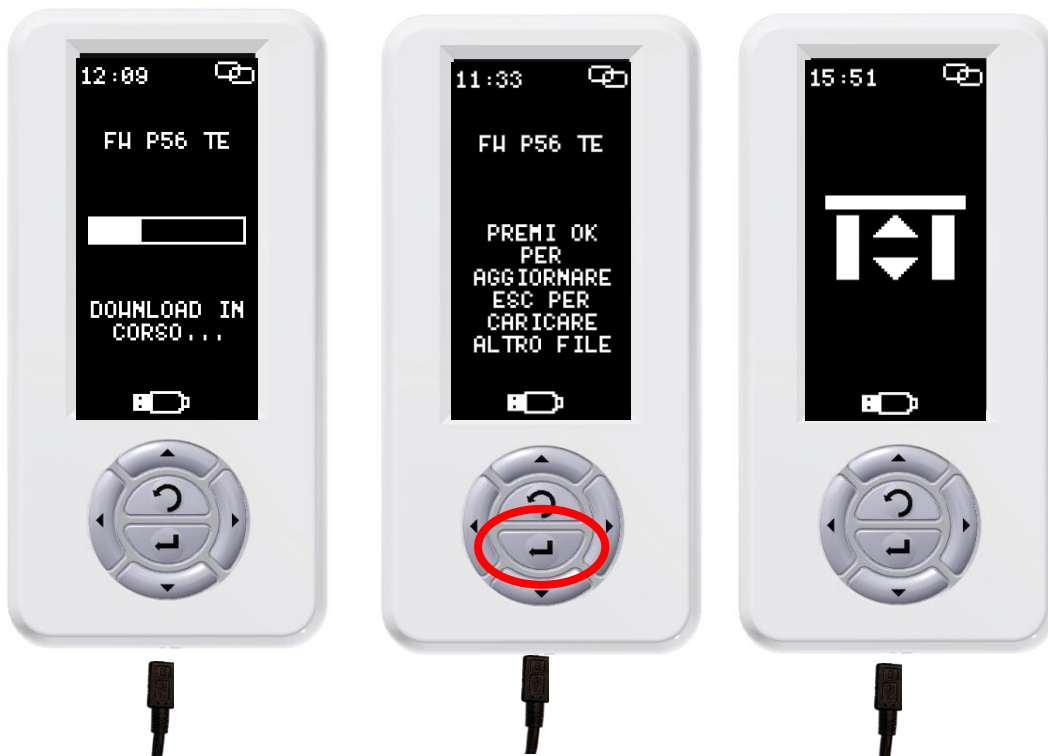

Update firmware board:

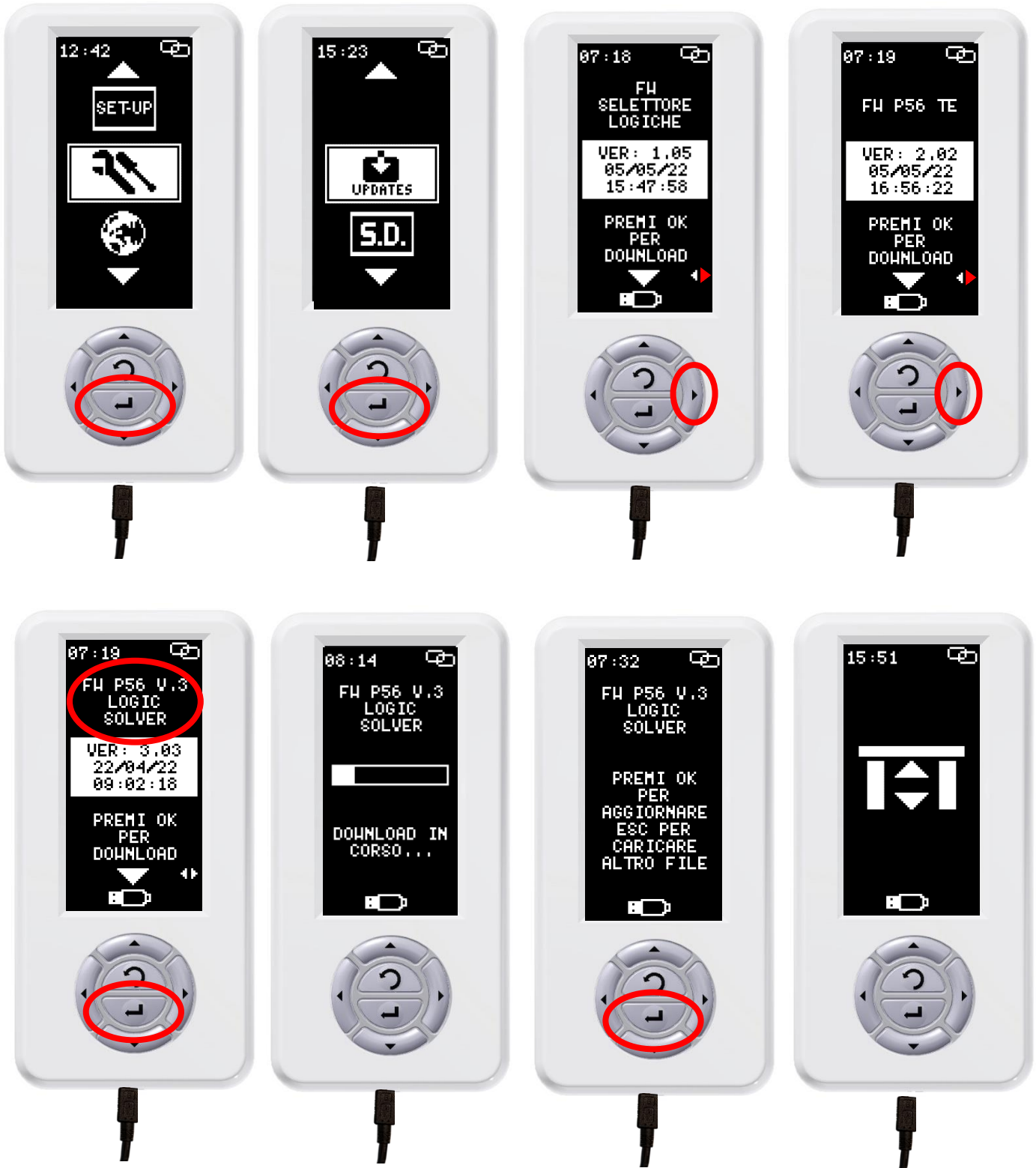

Note: If in the usb there are several firmware, to find the desired one press:



SET A DEFAULT

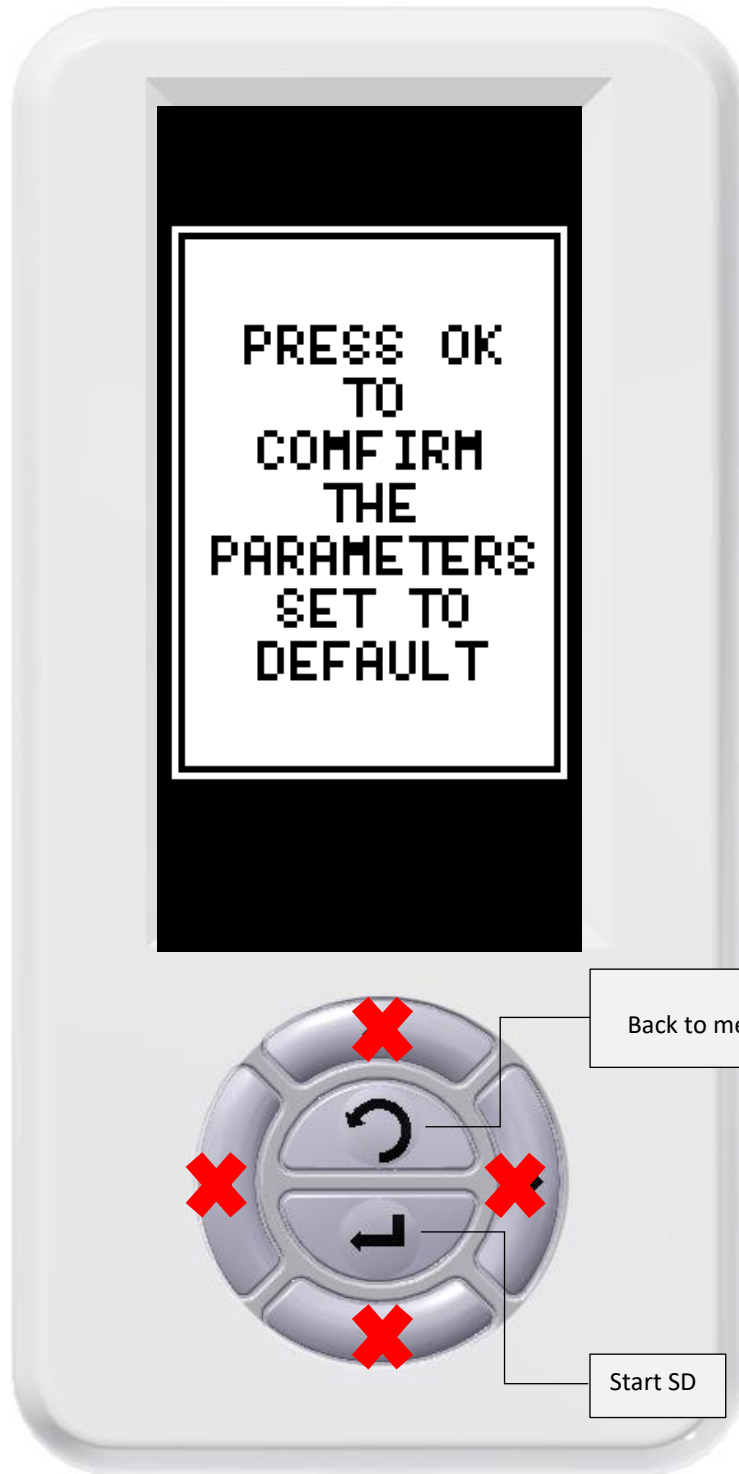

NOTE: SET A DEFAULT returns the main control board to factory settings and parameters, permanently losing all settings and learning stored.

Key selection: NAVIGATION MODE MENU



LANGUAGE SELECTION

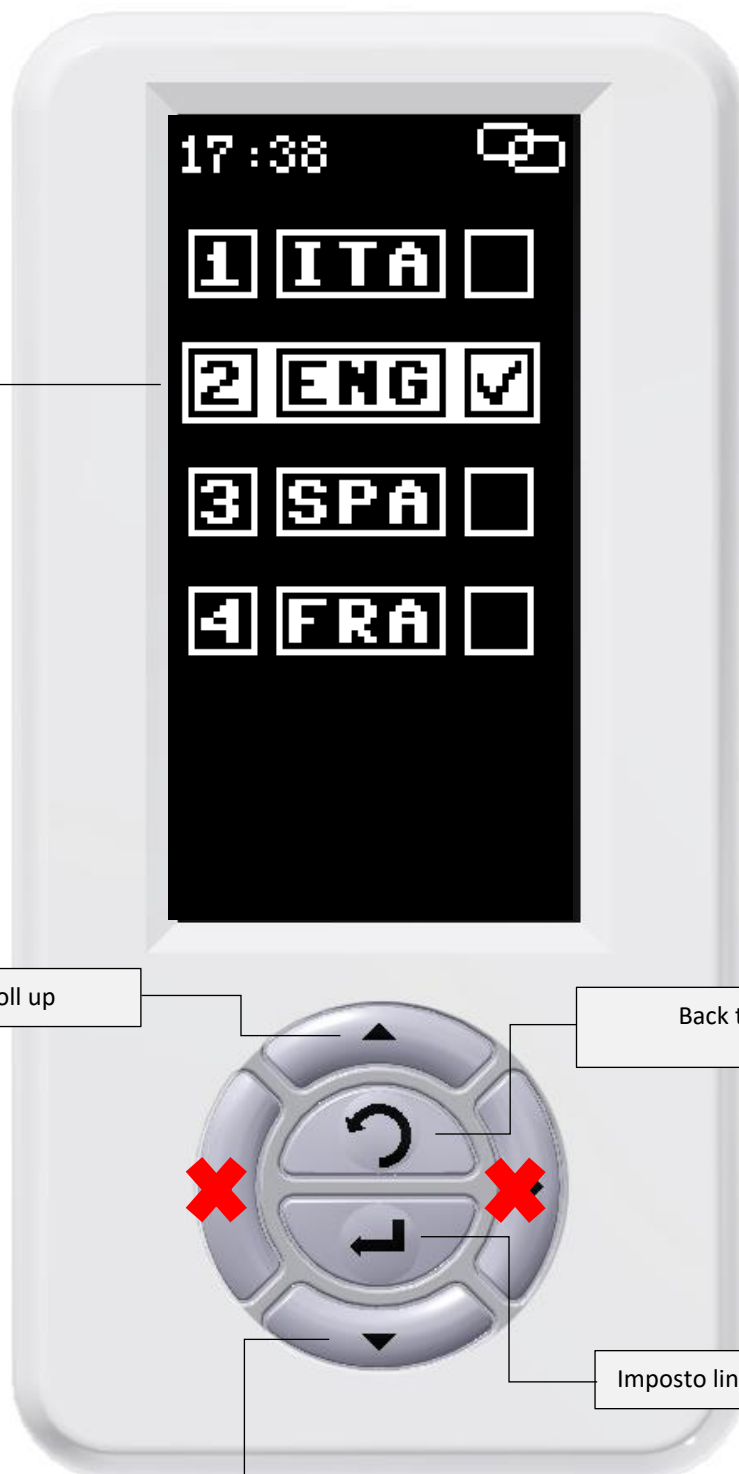

Indicates the language set

Scroll up

Back to menu SETTINGS



Imposto lingua

Scroll down

Key selection: NAVIGATION MODE MENU

TAG



Memory TAG

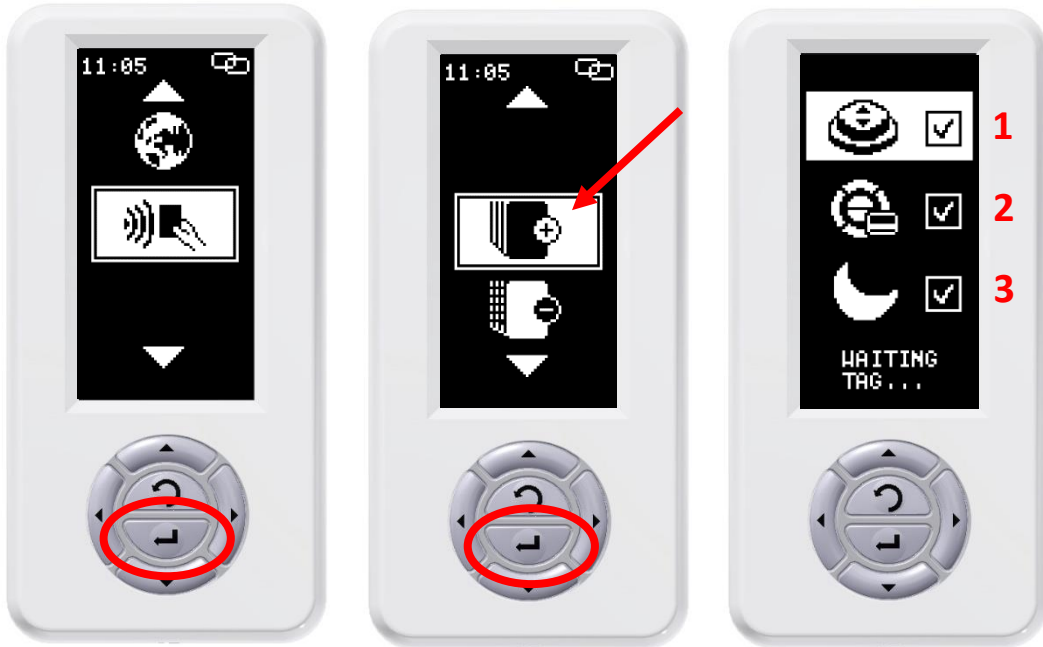

- 1. Opening command
- 2. Key lock
- 3. Night mode

TAG can memorize all three functions, one of the three or two of the three, to deselect / select see images



Deselected

Selected

Key selection: NAVIGATION MODE MENU 



TAG memorized



Key selection: NAVIGATION MODE MENU 

TAG deleting

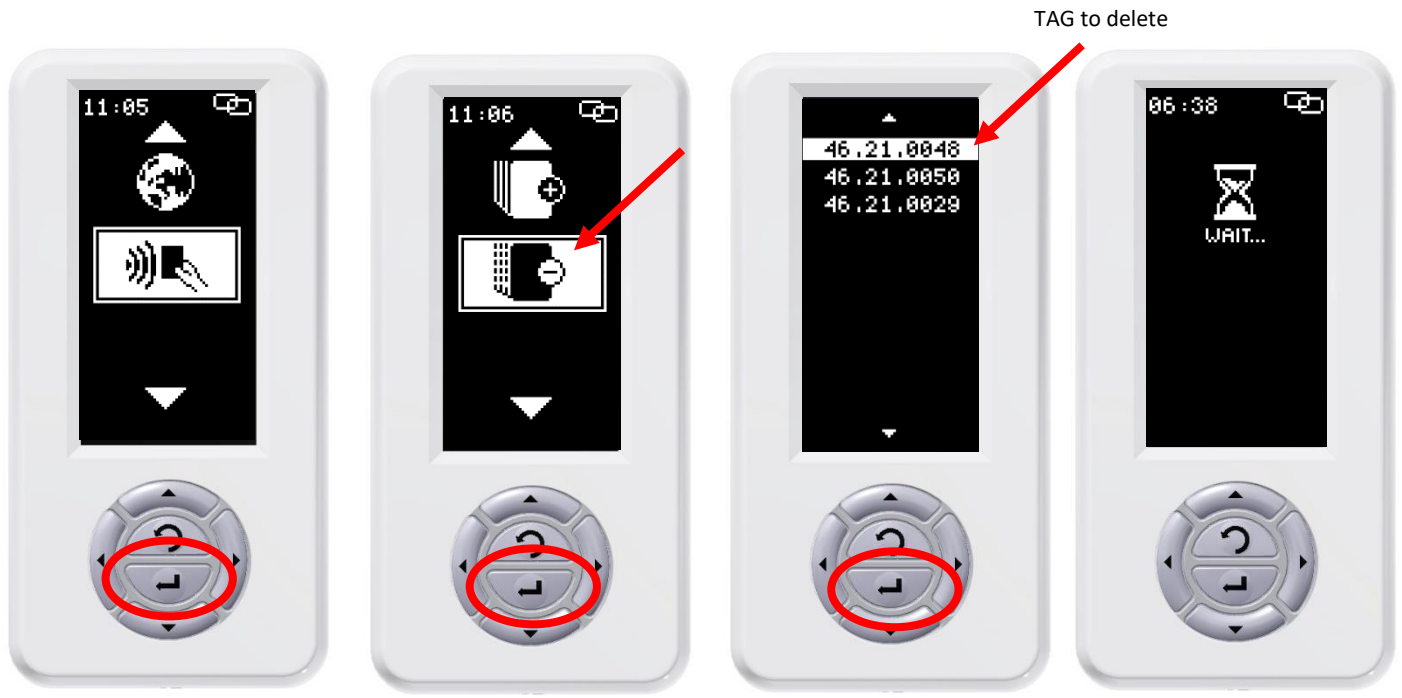

List of TAG memorized



Once deleted, TAG can be re-stored

Key selection: NAVIGATION MODE MENU



Use of TAG memorized

Tag memorized with all functions – setting function:

Approaching TAG to the area



Choosing function

Key selection: NAVIGATION MODE MENU 

Tag memorized with all functions – disable function:

Approaching TAG to the area



Key selection: NAVIGATION MODE MENU 

Tag stored with two functions – setting function:

Approaching TAG to the area



Key selection: NAVIGATION MODE MENU 

Tag stored with two functions – disable function:

Approaching TAG to the area



Key selection: NAVIGATION MODE MENU 

Tag stored with one function – setting function:

Approaching TAG to the area



Tag stored with one function – disable function:





Approaching TAG to the area





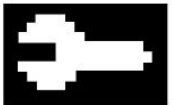

Key selection: NAVIGATION MODE MENU 

SIGNAL TABLE



String on top

ICONS	DESCRIPTION
	Indicates that the selector is regularly connected to the control board
	Indicates that control board and selector are disconnected
	Indicates that the selector is working in demo mode
	Indicates the presence of batteries. If flashing indicates malfunction
	Scheduled maintenance

String on bottom

ICONS	DESCRIPTION
	Indicates that the selector has been connected to a device via micro-usb, such as a PC or another Digidor.
	Indicates that a USB stick has been connected to the selector
	A USB stick is connected, indicating that it is looking for the connection
	Indicates an error/lack of connection between the Digidor and the connected device

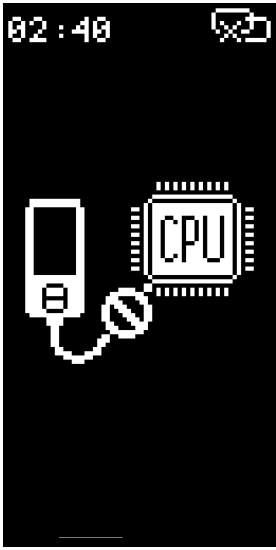
Main screen

ICONS	DESCRIPTION
	Indicates that the selector does not communicate with the control board / they are not connected
	Indicates the presence of an error (described in the communication screen). for the complete list of errors refer to the installation manual.

**WARNING!** This product falls within the scope of the Directive 2012/19 / EU concerning the management of waste for electrical and electronic equipment. (RAEE). The appliance must not be disposed of with domestic waste as it is made of different materials that can be recycled to suitable structures. Inquire through the municipal authority regarding the location of the ecological platforms suitable to receive the product for disposal and the subsequent correct recycling. It should also be remembered that, upon purchase of an equivalent appliance, the distributor is obliged to collect the product for disposal free of charge. The product is not potentially dangerous for human health and the environment, it does not contain harmful substances as per Directive 2011/65 / EU (RoHS), but if abandoned in the environment it negatively impacts on the ecosystem.



**The crossed-out bin symbol indicates the compliance of this product with the regulations regarding waste for electrical and electronic equipment. The abandonment in the environment of the equipment or the illegal disposal of the same are punished by law.**

C187540\_03\_MAN\_DG\_E\_20\_02\_23



SESAMO srl  
Str. Gabannone, 8/10  
15030 Terruggia (AL) Italy  
Tel: +39 0142 403223  
Fax: +39 0142 403256  
[www.sesamo.eu](http://www.sesamo.eu)  
e-mail: [info@sesamo.eu](mailto:info@sesamo.eu)