



Icon

SUMMARY

SUMMARY	2
GENERAL INFORMATION - INSTALLATION AND WIRING	3
KEY FUNCTIONS - LED INDICATIONS	5
FUNZIONALITÀ BASE - LOGICHE	6
FUNCTIONALITY - SERVICE KEYS	7
PROGRAMMING MODES	8
TRASPONDER FUNCTIONALITY	12
MICRO-USB FUNCTIONALITY	19

GENERAL INFORMATION - INSTALLATION AND WIRING

The "ICON" selector was created to work with all SESAMO operators, designed to be used both by the user for managing the door functionality and by the installer for adjusting the basic parameters of the door.

ICON must be installed inside of buildings.



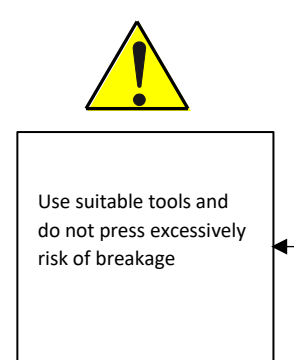
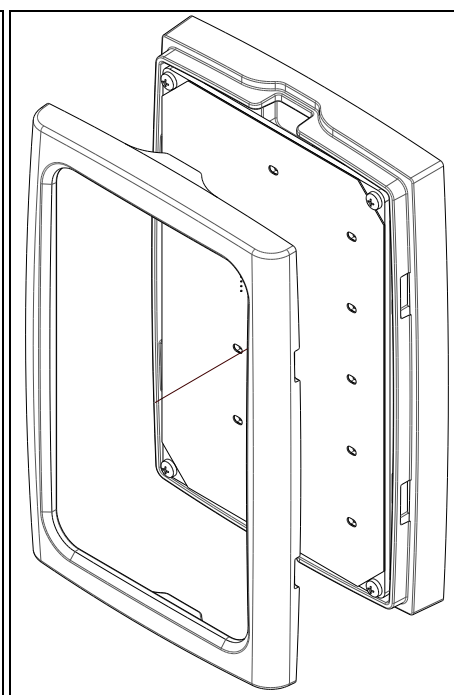
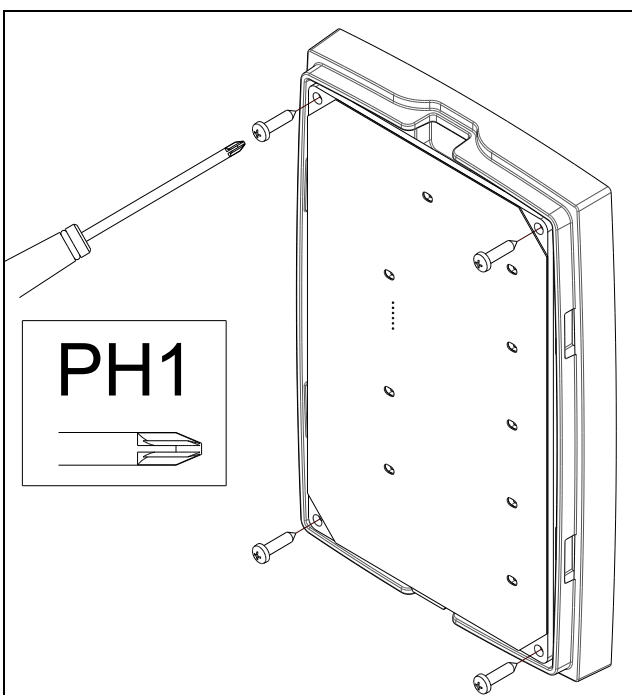
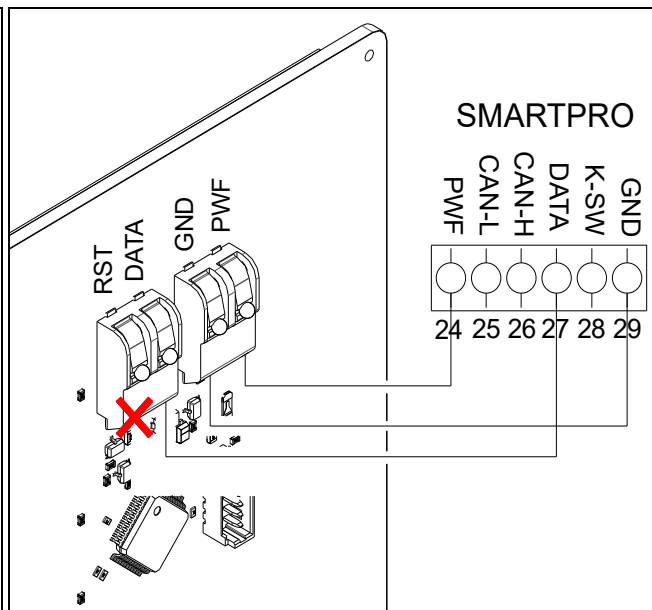
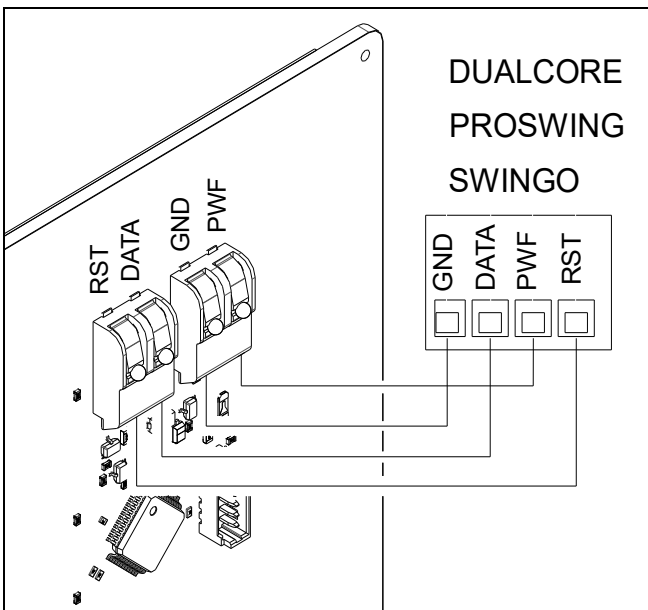
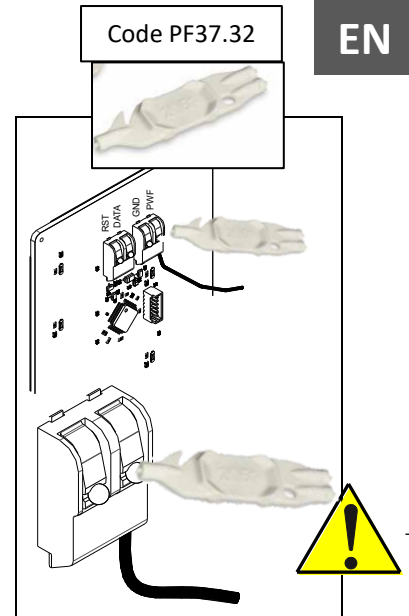
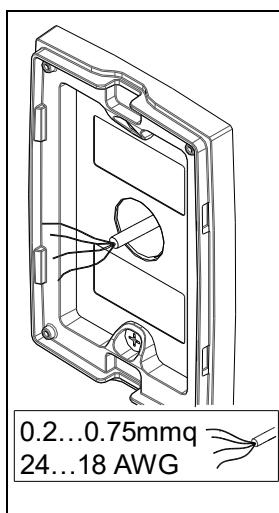
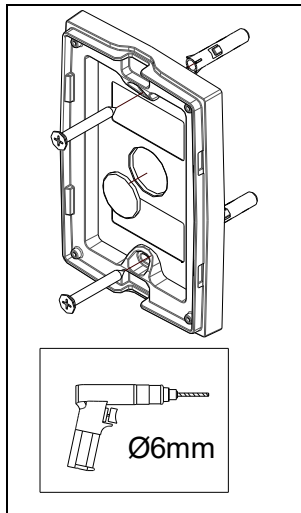
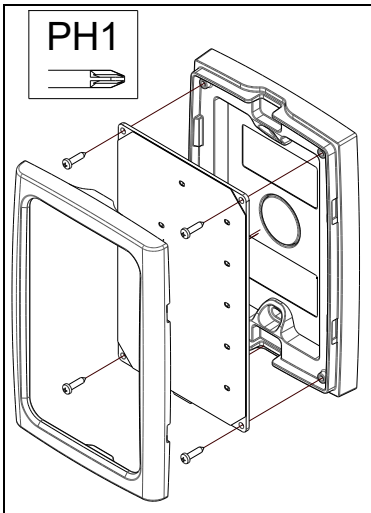

KEY FUNCTIONS - LED INDICATIONS

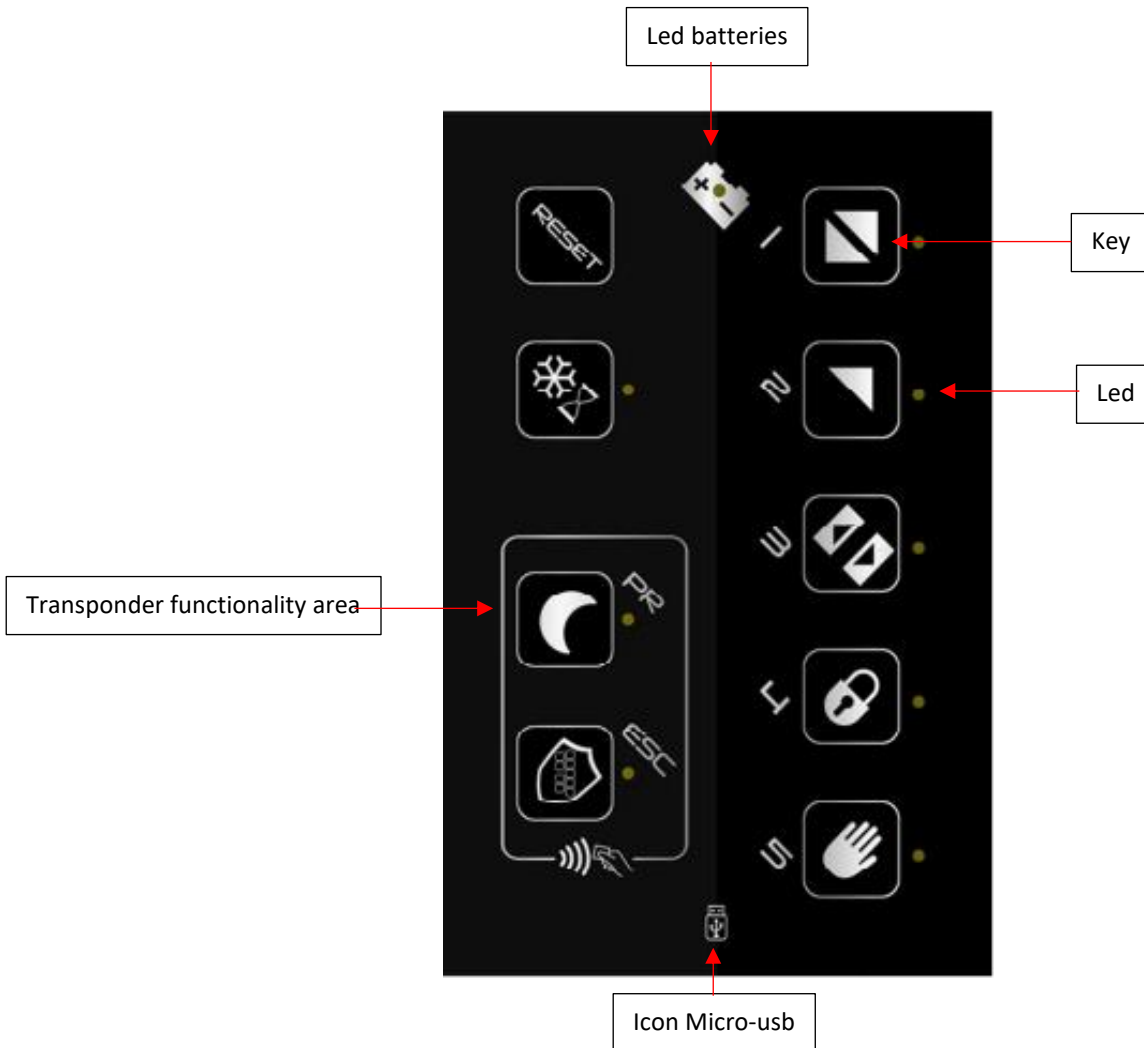

- To activate a logic / programming / choice, place your finger inside the key area indicated with a rectangle
- Keep your finger resting 1 second
- The LEDs next to the key areas indicate, if fixed, that the logic has been set correctly.
- The LEDs, if flashing, may have various indications based on the action you want to perform (they will be explained in the various paragraphs dedicated to the selector functions).
- The icon with the battery drawn and a LED in the center indicates:
 - if it is fixed that the automation is battery powered
 - if flashing that the batteries may be flat, malfunctioning or with a possible anomaly.
- The Micro - usb icon indicates the presence of a micro - usb port. To gain access, remove the upper body of the selector applied by interlocking.

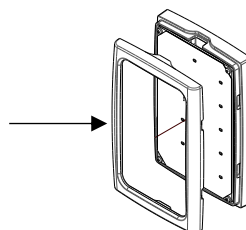

FUNZIONALITÀ BASE - LOGICHE

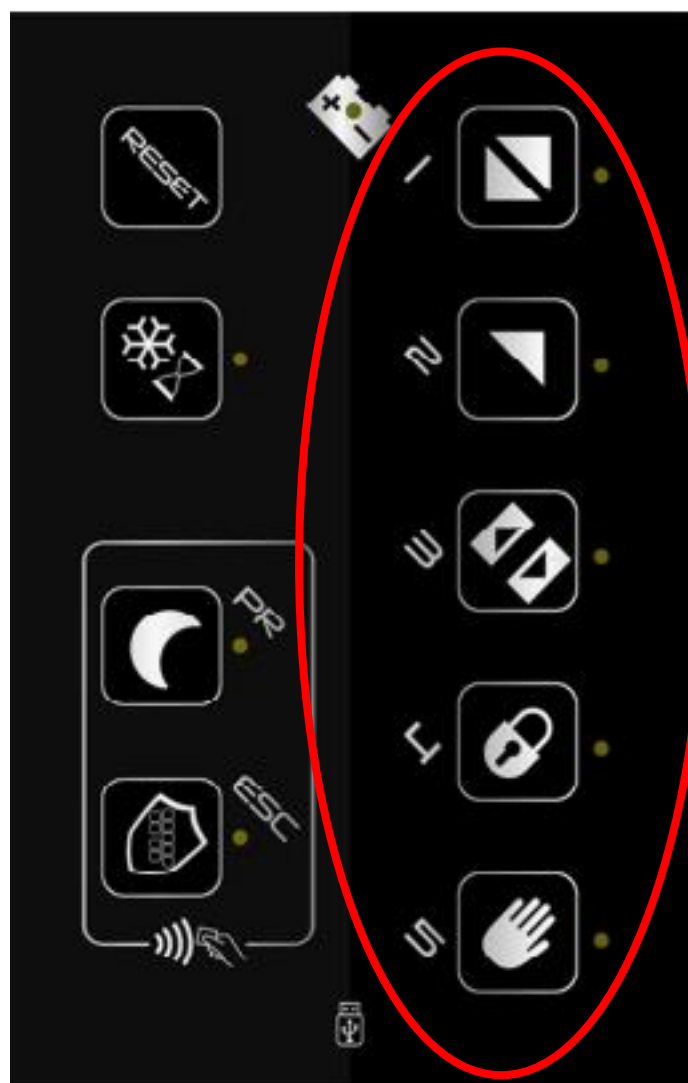

List of logics available:

1. 2 Radar (automatic)
2. 1 Radar (only exit)
3. Stop open
4. Stop close
5. Manual



Actions to be performed in order to set the chosen logic:

1. Place your finger in the desired key area for 1 second.
2. You will hear 1 beep.
3. The LED will turn on steadily
4. Logic is set.

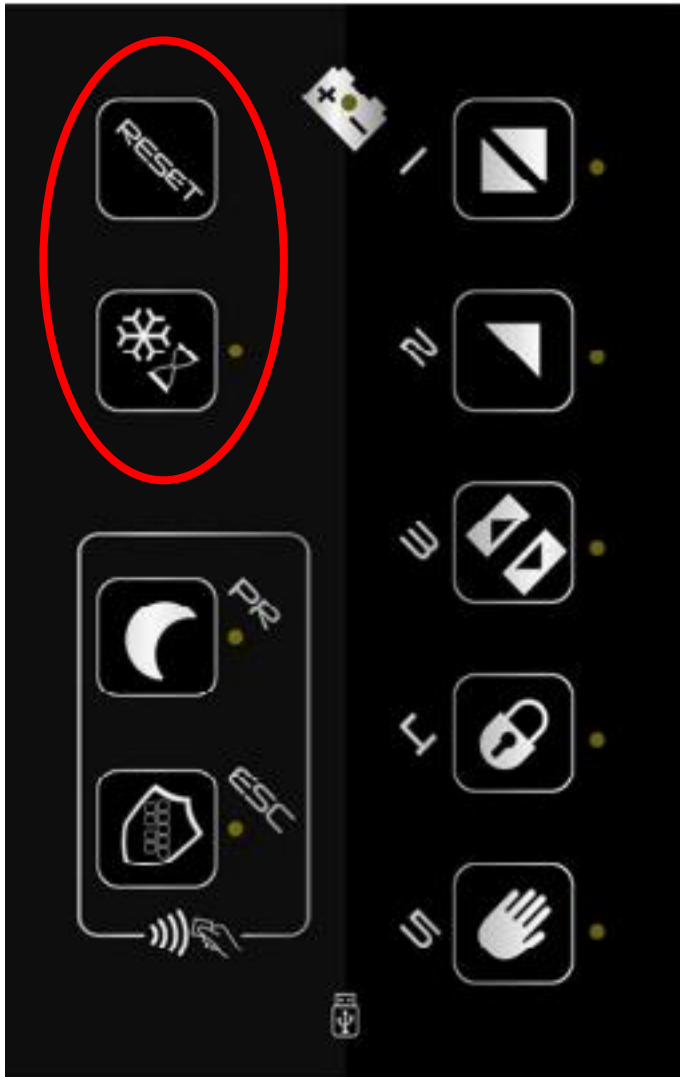
FUNCTIONALITY - SERVICE KEYS



Read the warnings carefully!!!!

1.  In case of partial opening selection with Stop open logic already active, it will be necessary to let the automation perform a complete opening cycle to make the partial opening settings active.
2.  In case of Reset, partial opening is disabled, unless a logic after reset (with Digidor) has been set already.
3.  The stop close logic is the only logic that cannot be combined with partial opening.



RESET - by placing the finger for 3 seconds, a reset command is confirmed to the main board



For sliding: by placing your finger (1 beep plus fixed LED) I link the "partial opening" logic to the logic previously preset (on the selector I will find two LEDs lit, one on the logic and the other on the snowflake icon)



For swing: not used

PROGRAMMING MODES

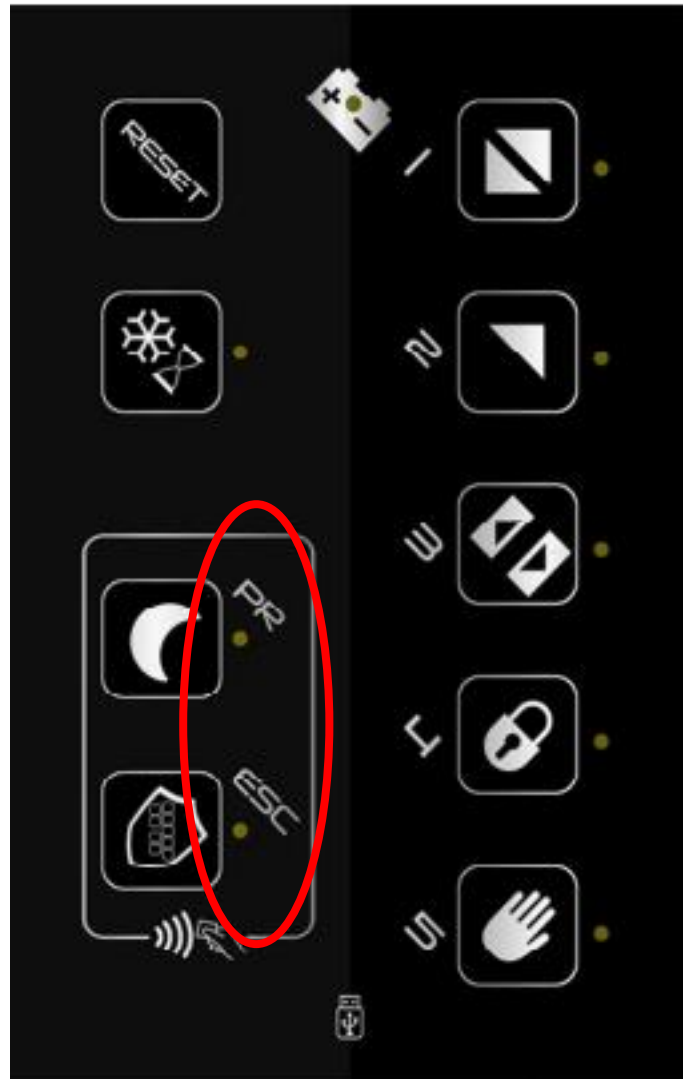

To be able to enter programming mode:



PR+ESC at the same time:

placing your fingers on the two keys at the same time for more than 3 "(1 beep as an indication) you enter the programming menu of the selector from where you can adjust some basic parameters. (see list with relative sequence explained below).



ATTENTION!!!

I understand that I have entered the programming menu because all the LEDs are flashing.

Sequence for setting parameters:

At this stage they are inside programming and all LEDs are flashing - choose the parameter to be set by placing your finger on the corresponding button.

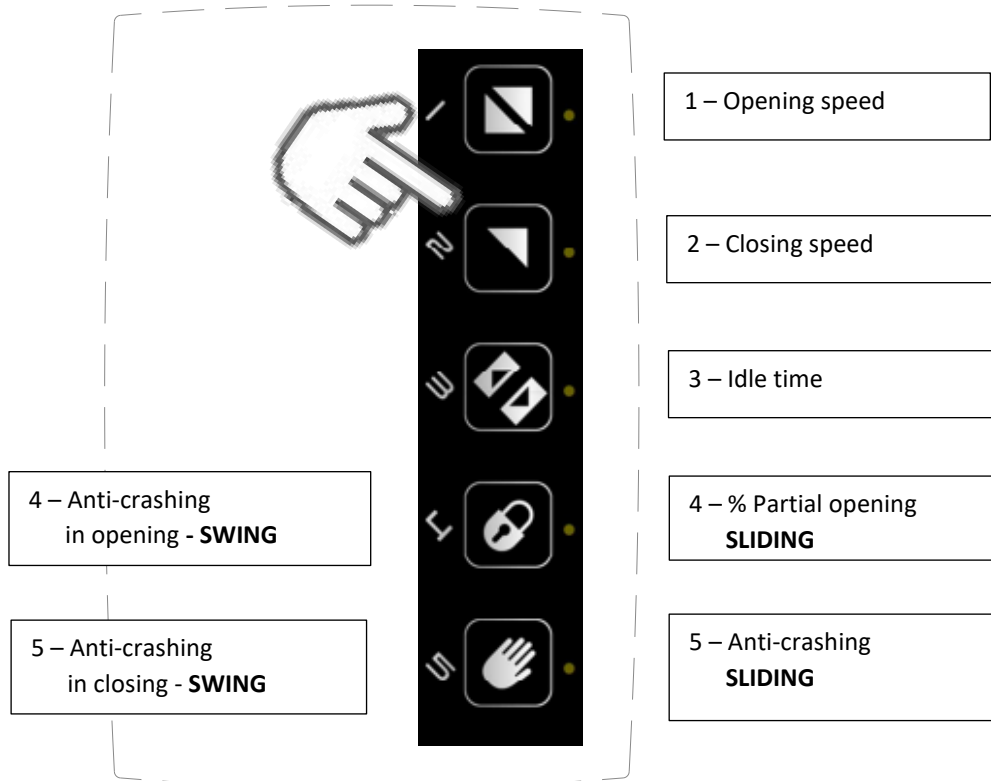

Once the parameter to be adjusted has been chosen, the lit LEDs will indicate the adjustment level (1 minimum - 5 maximum - see tables for automation references / values). By placing your finger on the button, I increase (if the LED is not on) or decrease (if the LED is on) the adjustment level

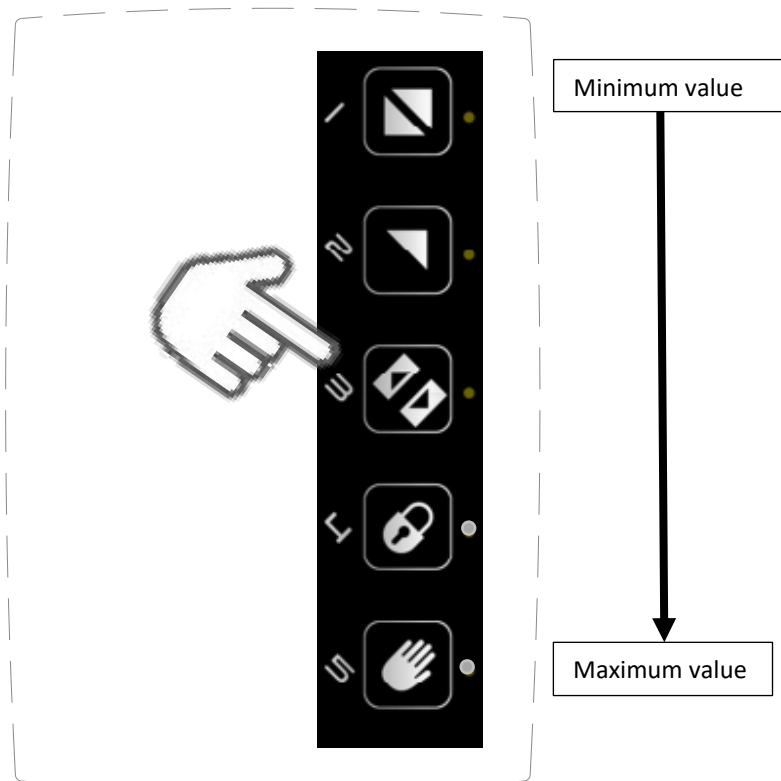

After adjusting the selected parameter to be able to store the adjustment:

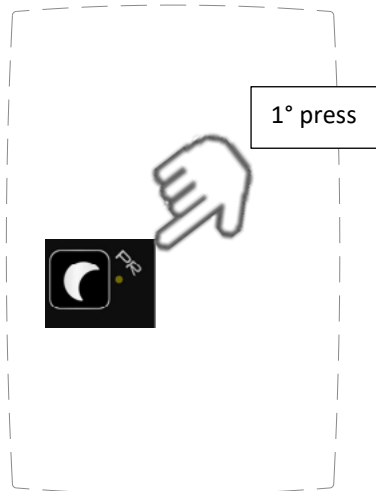

By placing your finger once
I **STORE ONLY THE SETTING SET**, I automatically return to the parameter selection mode (to be able to choose and set another parameter if necessary).

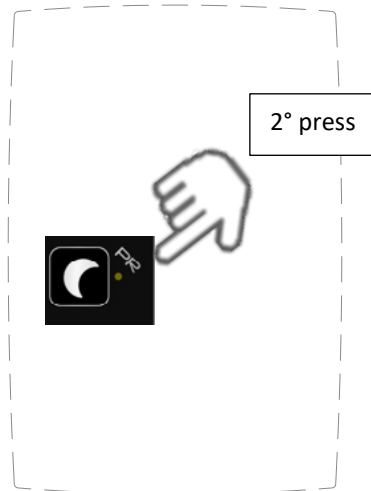

Placing the finger a second time I **ACTIVATE THE SET VALUES** and go back to the logic selection

In case you do not want to memorize the adjusted parameter:

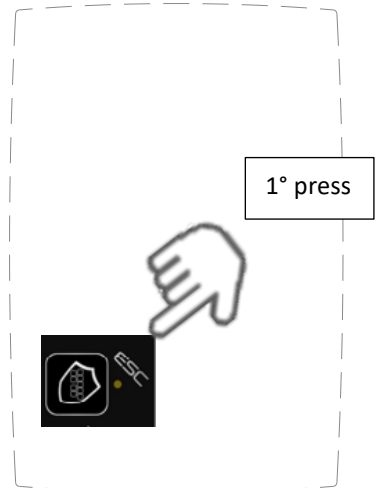

By placing your finger once
I **EXIT WITHOUT SETTING**, I automatically return to the parameter selection mode (to be able to choose and set another parameter if necessary).

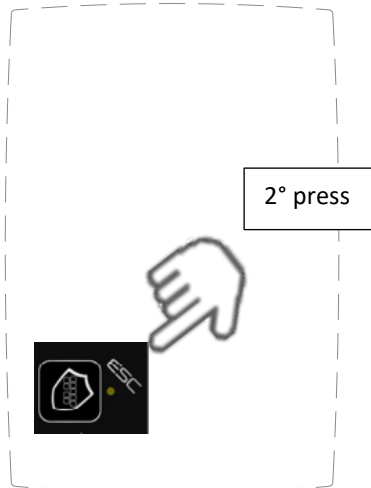

Placing the finger, a second time I **RETURN TO THE LOGIC SELECTION WITHOUT ACTIVATING ANYTHING**

Parameter adjustment tables based on the automation installed

Dualcore – sliding

N	Description	Levels				
		1	2	3	4	5
1	Opening speed	100mm/s	250mm/s	400mm/s	550mm/s	700mm/s
2	Closing speed	100mm/s	200mm/s	300mm/s	400mm/s	-
3	Idle time	0"	1"	3"	5"	10"
4	% Partial opening	30%	40%	50%	60%	70%
5	Anti-crashing	1	3	5	7	9

Smartpro / Proswing – swing

N	Description	Levels				
		1	2	3	4	5
1	Opening speed	20°/s	30°/s	40°/s	50°/s	60°/s
2	Closing speed	10°/s	20°/s	30°/s	35°/s	40°/s
3	Idle time	0"	1"	3"	5"	10"
4	Anti-crashing in opening	1	3	5	7	9
5	Anti-crashing in closing	1	3	5	7	9

Swingo – swing

N	Description	Levels				
		1	2	3	4	5
1	Opening speed	20°/s	30°/s	40°/s	50°/s	-
2	Closing speed	10°/s	20°/s	30°/s	35°/s	40°/s
3	Idle time	0"	1"	3"	5"	10"
4	Anti-crashing in opening	1	3	5	7	9
5	Anti-crashing in closing	1	3	5	7	9

TRASPONDER FUNCTIONALITY

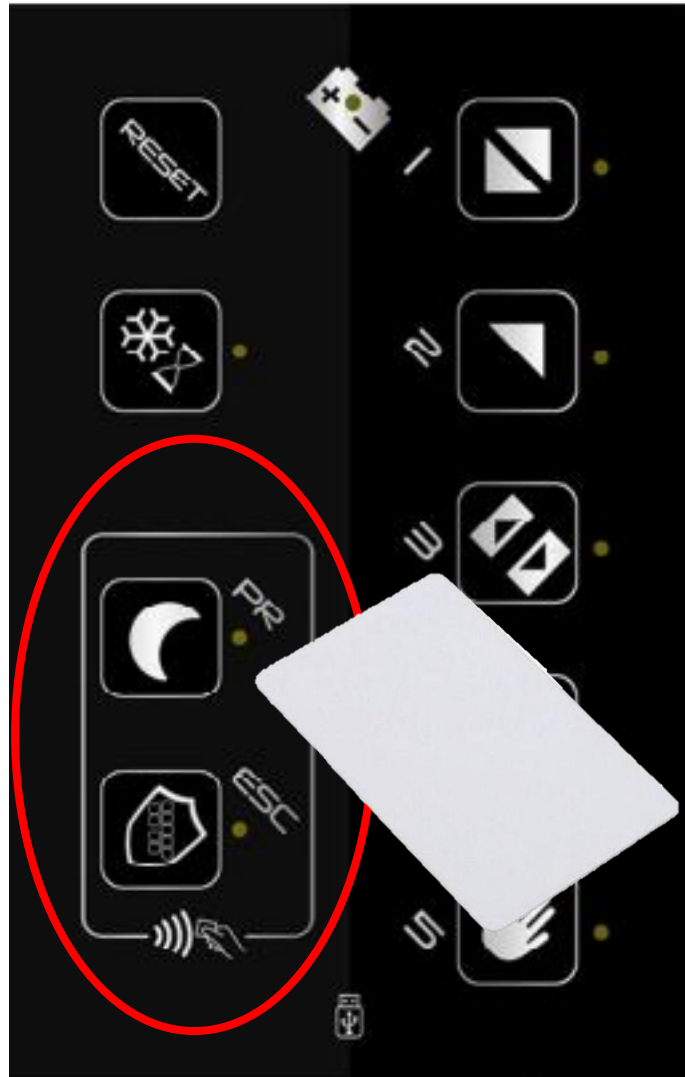

The area circled in red indicates the area in which to approach the Tag for use, **in any other area of the selector the TAG will not work**, the two icons indicate:



Function first opening / night mode lock

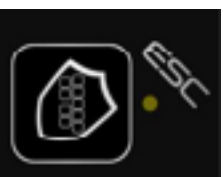

Keypad lock function



Attention read the following points carefully:

1. Number of usable TAGs = 3
2. The TAGs are already enabled as factory setting with functionality 2
3. In the event that the installer finds himself with some TAGs not enabled or wants to change the preset function, follow the operations described on page 14.
4. To change the factory setting of the TAG you must first perform the deletion procedure, see page 15.
5. In Proswing and Swingo operators the function **TAG IS NOT AVAILABLE!!!!**
6. To understand if a TAG is enabled, just bring it close to the detecting area:
 - if you hear a long beep it indicates that it is not enabled
 - if 1 beep is heard and the function is set or the two functions flash alternately (alternating flashing indicates the possibility to choose one of the two functions available) indicates that it is enabled.
7. TAG functions (can only be set on the electronic board and only by the installer):
 - 0 = Keyboard lock and unlock
 - 1 = Activation / deactivation of the first opening / night mode lock
 - 2 = Enabling of both functions

TAG Configuration:



The intervention of the installer is required as they must be enabled with an interaction between the automation electronic board and the ICON selector.

Sequence:

Search A.t. (Add-tag) on menu – press ENTER

Enter the menu and select the type of I want to enable (0,1,2) – press ENTER

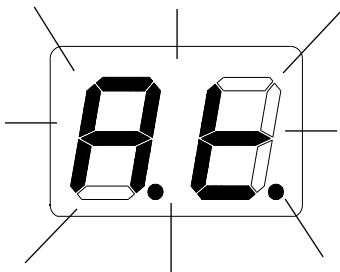
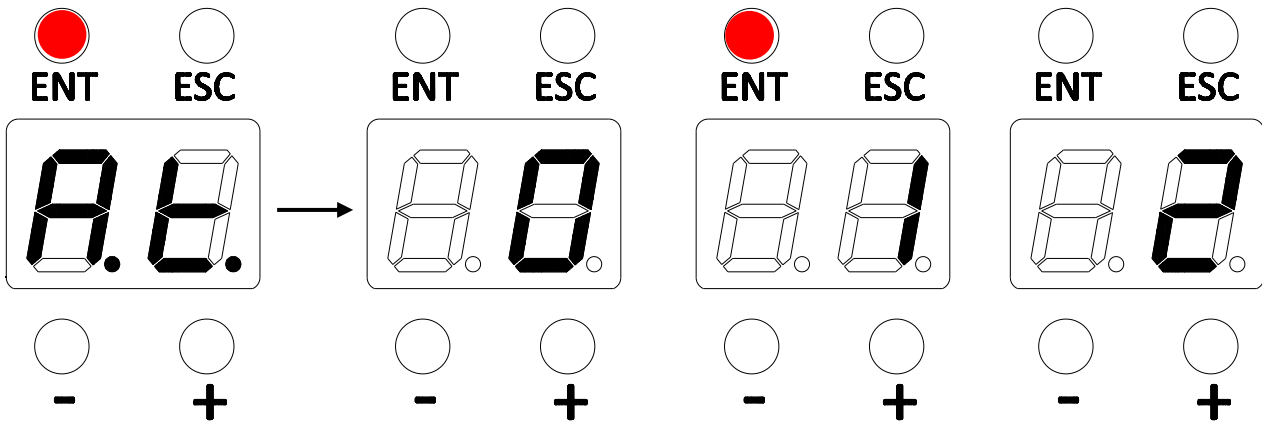

A.t. will start flashing on the board display. while the two LEDs of the TAG area will start to flash alternately on the selector.

All this indicates that you are ready to store the TAG.

The TAG will be enabled with the function previously chosen on the card.

To enable it, bring the card in the dedicated area, 3 beeps will be heard and the TAG will be enabled.

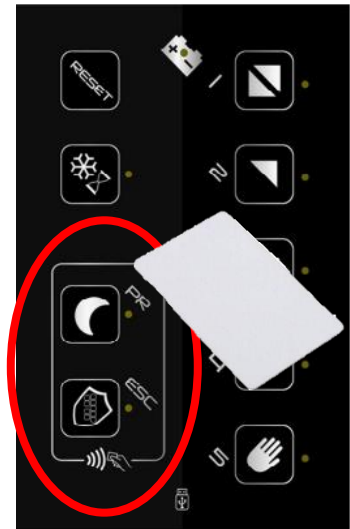

Once all the TAGs have been enabled, press ENTER or ESC to exit programming.

Cancellation of enabled TAGs:



The intervention of the installer is required as they must be disabled with an interaction between the automation electronic board and the ICON selector.

it is possible to cancel the enabling of TAGs in the following way:

Search for d.t. (delete-tag) on board menu display - press ENTER for 5 " automatically all stored TAGs will be disabled.

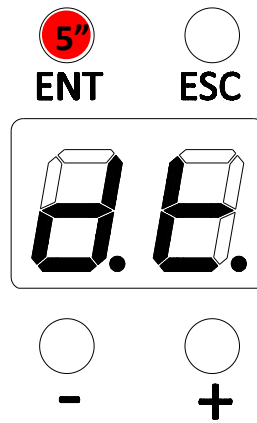

The TAGs CANNOT be disabled individually, you must disable them all and re-enable the desired ones.

The intervention of the installer is required

Use of enabled TAGs:

TAG enabled with value 0 = Keypad lock and unlock function



If the keypad lock is not yet activated:

approach the TAG once and activate the keypad lock function (1 beep - the LED next to the icon lights up).

If the keypad lock is activated:

approach the TAG once and disable the keypad lock function (1 beep - the LED next to the icon turns off).

TAG enabled with value 1 = Activation / deactivation of the first opening - night lock mode



If the first opening is not yet activated:

approach the TAG once and activate the first input function (1 beep - the LED next to the icon lights up).

If the first opening is activated:

approach the TAG once and disable the first input function (1 beep - the LED next to the icon turns off).



ATTENTION!!!! WHEN I ACTIVATE THE FIRST OPENING LOGIC FROM THE SELECTOR, THE ICON LED WILL BE FIXED AND I WILL BE ABLE TO DEACTIVATE IT WITH MY TAG CARD. IF, HOWEVER, I FIND THE LOGIC ACTIVE BUT WITH THE LED FLASHING, IT INDICATES THAT IT HAS BEEN INSIDE WITH A KEY CONTACT AND I WILL NOT BE ABLE TO DEACTIVATE IT WITH MY CARD.

TAG enabled with value 2= Enabling of both functions: keypad lock + first opening - follow table

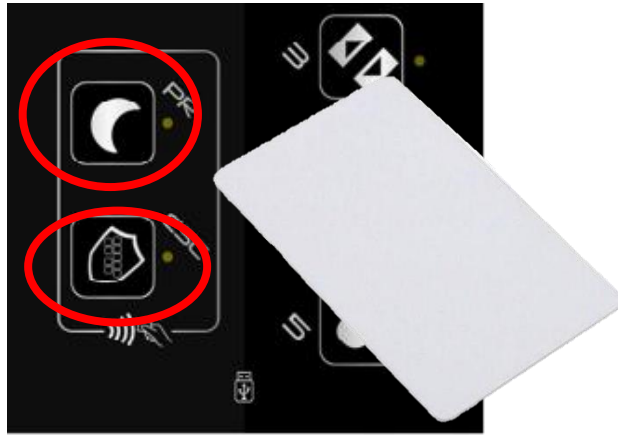

Case A: No function set on the selector

1 – Bring TAG closer



2 – Alternating flashing of LEDs

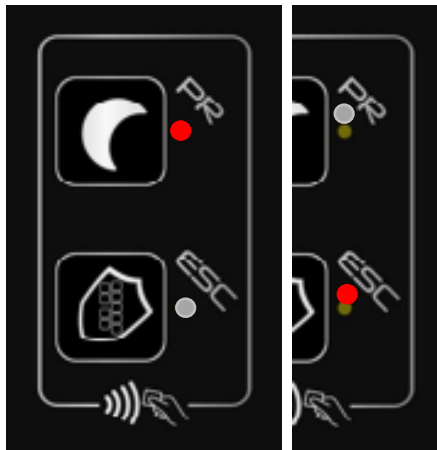

3 – Place finger on selected logic

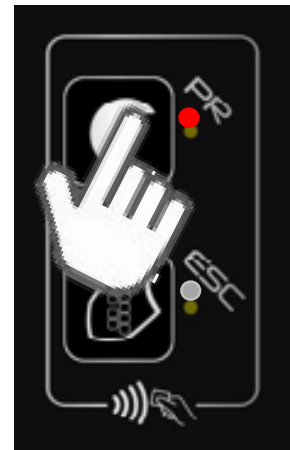

This procedure must always be used to activate a function

Case B: A function already set, example "First opening"

1 – Bring TAG closer



2 – Alternating flashing of LEDs

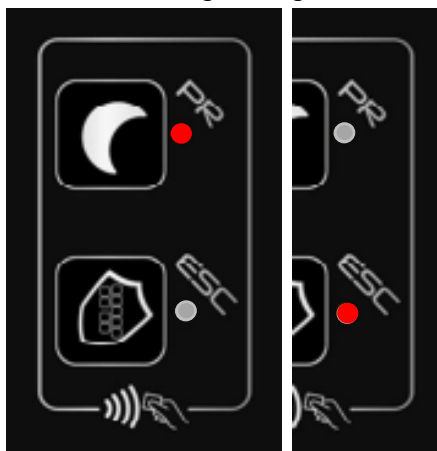

3 – Place finger on selected logic



This procedure must always be used to deactivate a function

Case C: A function that has already been set for example "Night mode"

1 – Bring TAG closer



2 – Alternating flashing of LEDs

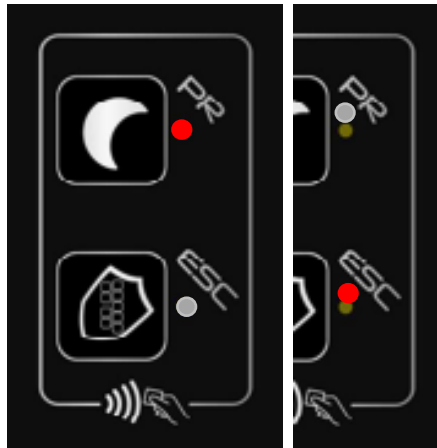

3 – Place finger on selected logic

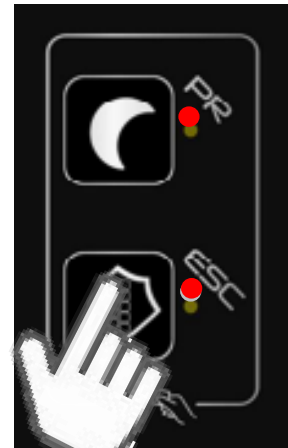

This procedure must always be used to activate the function that has not yet been set

Case D: Both functions set

1 – Bring TAG closer



2 – Alternating flashing of LEDs

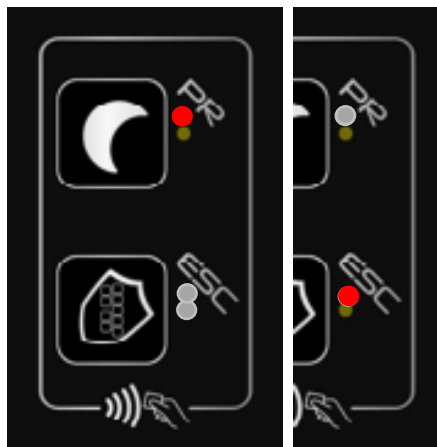

3 – Place finger on the function to deactivate

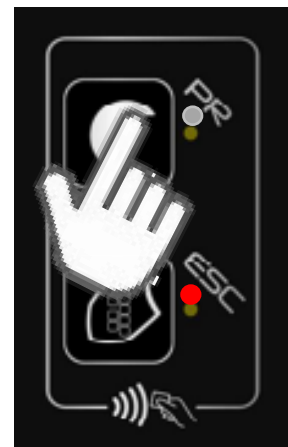

If you repeat the sequence and place your finger on the other icon of the active function, that will also be disabled.



ATTENTION!!!! WHEN I ACTIVATE THE FIRST OPENING LOGIC FROM THE SELECTOR, THE ICON LED WILL BE FIXED AND I WILL BE ABLE TO DEACTIVATE IT WITH MY TAG CARD. IF, HOWEVER, I FIND THE LOGIC ACTIVE BUT WITH THE LED FLASHING, IT INDICATES THAT IT HAS BEEN INSIDE WITH A KEY CONTACT AND I WILL NOT BE ABLE TO DEACTIVATE IT WITH MY CARD.

MICRO-USB FUNCTIONALITY



In order to access the micro-usb port, remove the front cover by using a screwdriver in the appropriate clicks indicated in the figure with arrows.



The micro-usb port is for exclusive use for the connection, using commercial cables not supplied, of the Digidor or Digidor T or Digidor BT (EXCLUDING BLUETHOOTH FUNCTION - NOT WORKING). Once connected, the Digidor will be functional and usable (for functionality see Digidor manual).



ATTENTION!!!!!! The following peripherals **CANNOT** be connected to the Micro-usb:

- PC
- USB Keys
- Selector ICON

ATTENZIONE! Questo prodotto rientra nel campo di applicazione della Direttiva 2012/19/UE riguardante la gestione dei rifiuti di apparecchiature elettriche ed elettroniche (RAEE). L'apparecchio non deve essere eliminato con gli scarti domestici in quanto composto da diversi materiali che possono essere riciclati presso le strutture adeguate. Informarsi attraverso l'autorità comunale per quanto riguarda l'ubicazione delle piattaforme ecologiche atte a ricevere il prodotto per lo smaltimento ed il suo successivo corretto riciclaggio. Si ricorda, inoltre, che a fronte di acquisto di apparecchio equivalente, il distributore è tenuto al ritiro gratuito del prodotto da smaltire. Il prodotto non è potenzialmente pericoloso per la salute umana e l'ambiente, non contenendo sostanze dannose come da Direttiva 2011/65/UE (RoHS), ma se abbandonato nell'ambiente impatta negativamente sull'ecosistema.



Il simbolo del bidone barrato indica la rispondenza di tale prodotto alla normativa relativa ai rifiuti di apparecchiature elettriche ed elettroniche. L'abbandono nell'ambiente dell'apparecchiatura o lo smaltimento abusivo della stessa sono puniti dalla legge.

C187640_01_MAN_IC_EN_20_02_23



SESAMO srl
Str. Gabannone, 8/10
15030 Terruggia (AL) Italy
Tel: +39 0142 403223
Fax: +39 0142 403256
www.sesamo.eu